

PRODUCT CATALOGUE 24V

1219

PRODUCT CATALOGUE 24V



Content



General notes

- 04 preface introduction
- 08 the system



Lamps

- 12 rear lamps
- 36 position lamps
- 45 side marker lamps
- 53 end outline marker lamps
- 58 number plate lights
- 61 number plate holder
- 62 additional brake lamps
- 63 working lamps / reversing lamps
- 66 interior lamps



Standard wiring systems

- 70 front connection
- 70 main cables
- 71 SML-loom / flat cables
- 71 distribution cables
- 72 adapter cables
- 73 extension cables



Junction boxes

- 76 3-socket junction box
- 77 junction box ASS1



Rear bumper

80 rear bumpers



Spare parts and accessories

- 84 LED control gears
- 86 RDC - Premium
- 88 SMCG - side marker control gear
- 88 ERD - electronic reverse light device
- 90 electronic reversing buzzer
- 90 voltage reducer
- 92 spare parts and connection elements
- 94 reflectors
- 96 extension cables
- 96 Smartlink
- 97 marker boards
- 97 enlargements
- 98 ISO plugs and sockets
- 99 contour marking tape



Installation regulations

102 installation regulations



Attachments

- 110 part numbers summary
- 112 wiring diagrams
- 113 approval numbers

PACKAGING UNITS



Quantity per palett



Quantity per package

Aspöck Systems

Aspöck Systems – we bring light to the road

At Aspöck Systems we have made our business design, development and build the best possible solutions for European vehicle manufacturers. And we are now the complete range of vehicles.

Individual systems – Satisfied customers. Since their inception in 1977, Aspöck Systems GmbH has focused on a philosophy that has made it one of today's leading producers of lighting systems for the vehicle industry, developing standardized solutions for each individual customer. This flexibility has become the successful trademark of Aspöck Systems.

Innovative products. We see it as our obligation to make our entire range of cable and light systems compatible with the state-of-the-art, and play a pioneering role in setting new standards. We apply waterproof cables, connection systems and LED lighting to every field of application.

Continuous growth. Our headquarters in Peuerbach, Upper Austria has undergone continuous expansion in the production, storage and management sectors. Every year we invest in new production facilities, testing equipment and development systems to remain at the cutting edge of technology. At the same time we promote the further education and training of our employees, so that they always have the right answer when confronted with difficult questions, such as specific legislation issues.



Aspöck Systems GmbH

Subsidiaries.

A perfectly organised sales and service network throughout Europe guarantees best delivery times and a high degree of technical expertise. Many of the sales and production sites are our own subsidiaries, those of sales partners.

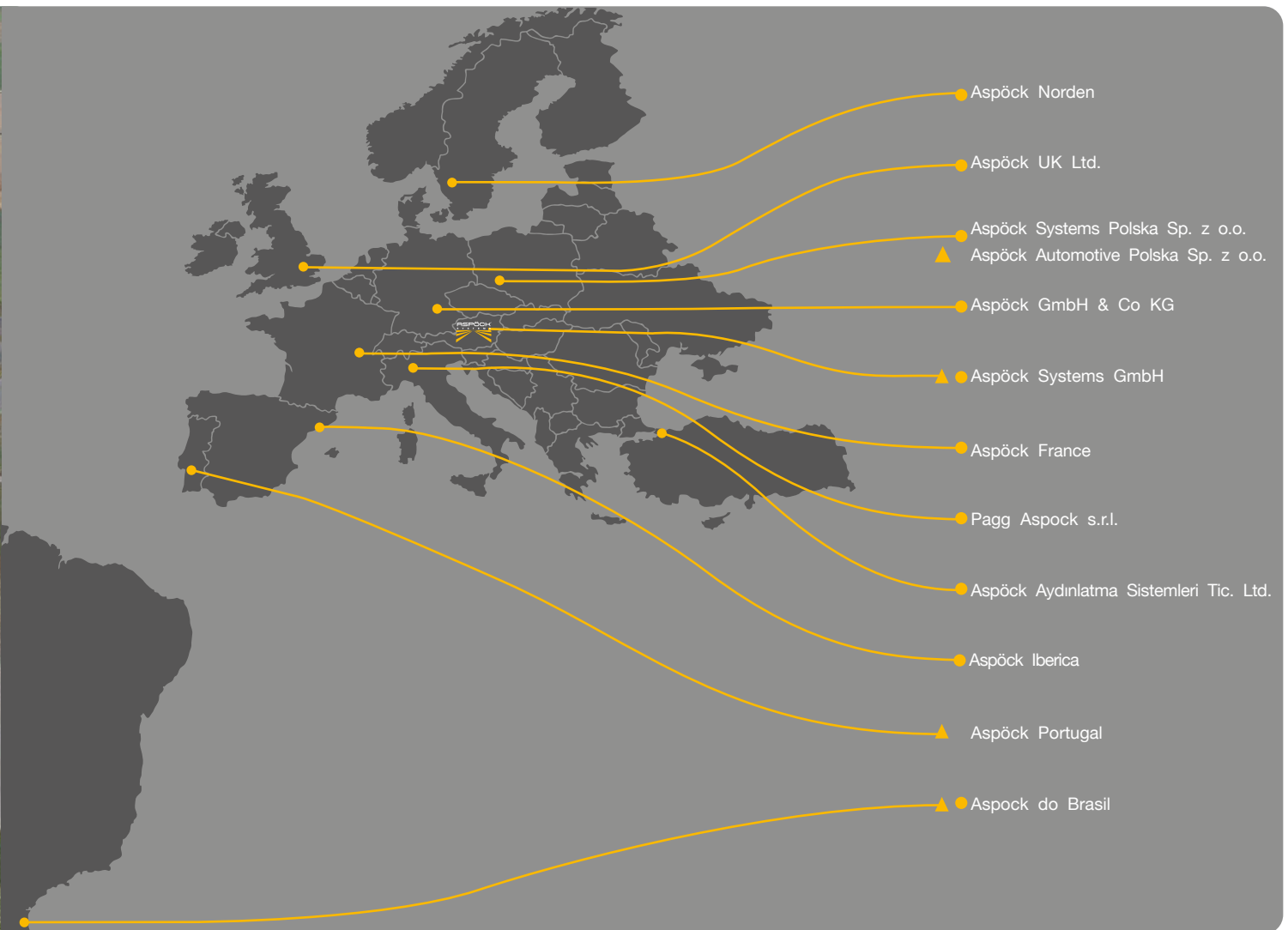

● Sales
▲ Production

Milestones

'77

Aspöck company founded as manufacturer of lighting systems for agricultural vehicles.

'81

First production workshop opens in Peuerbach

'82

First Aspöck connector system developed;
new customers: car trailer manufacturers

'88

Formation of Aspöck Germany

'91

New customers: caravan manufacturers

'92

New customers: truck trailer manufacturers

New customers: car manufacturers

'06

Formation of Aspöck Norden

New customers: truck manufacturers

Renaming Fabrilcar as Aspöck Portugal

'08

New customers: motorcycle manufacturers

Take-over Fabrilcar

Extension of the manufacturing base location: Portugal

'11

Implementing of the fully automated high rack ware-house in Peuerbach

Formation of Aspöck Poland

'05

'07

'09

'12

'96

First Aspöck
„Multipoint“ light
produced

'97

New customers:
bicycle carrier rack
manufacturers

'99

Gründung
Aspöck Iberica
Gründung
Trailer Lite

'01

Formation of
Aspöck Iberica and
Formation of
Trailer Lite

'03

Partnership
PAGG Aspöck

'04

Introduce
moulding
technology to
connector systems

„Europoint III“
The first lamp with
a „Light Guide“ for
trailers

Formation of
Aspöck Turkey

'13

Opening of new
manufacturing base
location: Poland

'16

Extension of the
manufacturing base
location: Portugal

'15

New building for loca-
tion: Peuerbach

New tail light:
ECOLED II

LumEU powered by
Aspöck - LED-Stripes

'18

New building
for office and
logistics
location: France

'17

Extension of the
manufacturing base
Location: Automotive
Polen

'19

Aspöck cable systems

Aspöck connector systems

Aspöck cable systems consists of 2-, 3-, 7- and 17-pin connectors and sockets. Each cable system is available to match every 24 V trailer. Aspöck connector systems enable all components to be connected up easily. All plug/socket units are moulded and approved to protection class IP69K (waterproof against spray water and when submerged in water).

2-pin ASS1 plug



The 2-pin ASS1 plug and socket housing enable connections to be made quickly for systems such as: position lights, side lights and outline lights as well as additional functions requiring a 2-pin connection.

3-pin ASS3 plug



Thanks to its small diameter, the 3-pin ASS3 plug offers speed and flexibility during installation. The ASS3 can also be used for 3-pin additional functions.

2-pin ASS2 plug



The 2-pin ASS2 plug is a further development of the 2-pin ASS1 plug – the advantage is an additional bayonet connection. This system enables connections to be made quickly and reliably for systems such as: position lights, side lights and outline lights as well as additional functions requiring a 2-pin connection.

7-pin ASS2 plug



Aspöck rear lights are linked to the Aspöck connection system using this 7-pin plug. The 7-pin plug and moulded housing can also be used for other additional functions.

17-pin ASS3 plug





The 17-pin plug and moulded housing are used to connect front-end power supply, main cable and rear cable system as well as linking up to an additional distributor.

Press & Ready System (P&R)



The P&R cable system offers an additional method of establishing contacts quickly and easily for vehicle installations. All Aspöck single-function lights can be equipped and connected using the P&R System. The cables can be supplied in different lengths to match each application. These lights can be mounted at any point on a 2-core flat cable and have already been function tested. Because each individual conductor features a silicon seal, the system is completely waterproof and can even be used for hazard goods transport applications (ADR).

	DESCRIPTION	PART NO
	P&R-tool/plier	10-0100-517
	cap for P&R connector	15-5971-007

Dimensions of various types of connector

2 pin ASS1 male

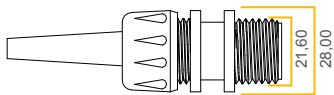

2 pin ASS1 female

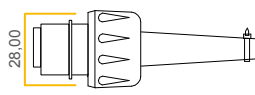

2 pin ASS2 male

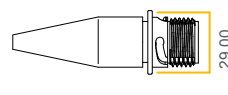

2 pin ASS2 female

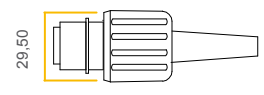

3 pin ASS3 male black

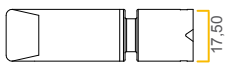

3 pin ASS3 female black

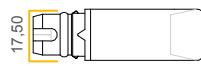

7 pin ASS1 male

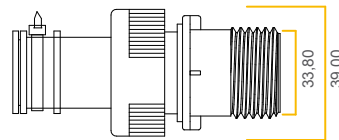

7 pin ASS1 female

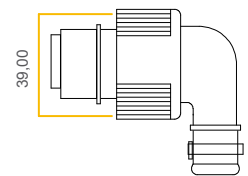

7 pin ASS2 male

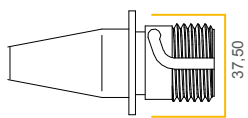

7 pin ASS1 female

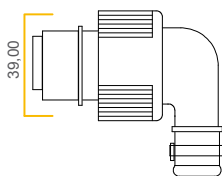

7 pin ASS2 male

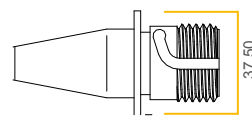

7 pin ASS2 female

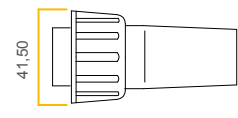

7 pin ASS2 male

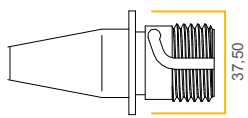

7 pin ASS2 45° female

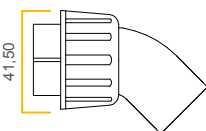

7 pin ASS2.1 male
only on rear lamps



7 pin ASS2 female

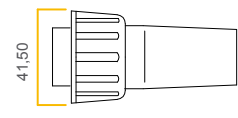

7 pin ASS2.1 male
only on rear lamps

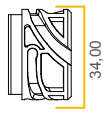

7 pin ASS2 45° female

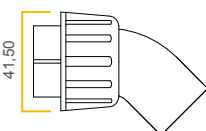

17 pin ASS3 male

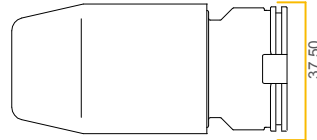

17 pin ASS3 female

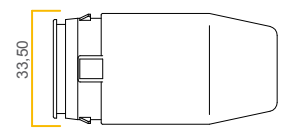

P&R System

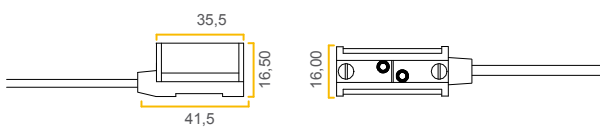

Connector Service Set

Aspöck 2-, 3-, 7- and 17-pin service and spares sets are available for integrating customer-specific lights or assemblies into the Aspöck connection system and retrofitting Aspöck components.

24V Lamps







* ECOLED II

WITH 7 PIN ASS2 CONNECTION

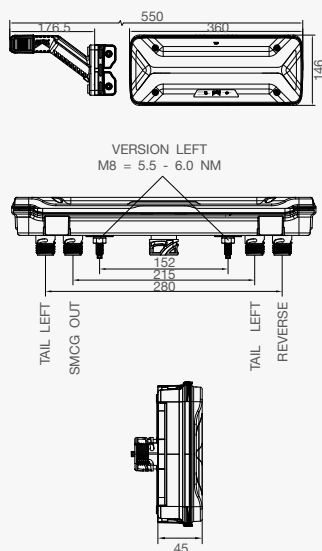

GENERAL DESCRIPTION

- LED Rear Lamp with replaceable lens.
- Spare lens can be used on both sides.
- Reduction in the variety of spare parts: By simply rotating the lens, the Rear Lamp can be adjusted to the mounting position (LH / RH).
- Innovative Glowing Body Technology as Tail Light.
- Increased visibility due to large luminous area of the Tail & Stop Light functions.
- Progressive Direction Indicator.
- ISO pulse 13207-1 as standard (for 24 V).
- Practical click system facilitates the mounting of the lens.
- Chemical and scratch-resistant lens.
- SMCG (Sidemarker Control Gear) included (for version with 2-pin outputs) according to ECE 48, Rev. 6.
- Intelligent partial deactivation of the Stop Light when the rear fog light is activated.
- LED End Outline Marker is mounted with a mounting bracket which has a predetermined breaking point.
- Optional with 4 x 2-pin connections on the rear of the lamp (distributor function).
- Individual LED modules are IP6K9K tested.

DESCRIPTION

- left 7 pin
- right 7 pin
- left 7 pin + 4 x 2 pin ASS2
- right 7 pin + 4 x 2 pin ASS2
- left 7 pin + 4 x 2 pin ASS2
- Superpoint IV
- right 7 pin + 4 x 2 pin ASS2
- Superpoint IV



192		8
192		8
192		8
192		8
128		8
128		8

PART NO

25-4121-007
25-4120-007
25-4121-017
25-4120-017
25-4121-027
25-4120-027

WITH 7 PIN AMP (DIN 72585) CONNECTION

DESCRIPTION

- left 7 pin
- right 7 pin
- left 7 pin + 4 x 2 pin SuperSeal
- right 7 pin + 4 x 2 pin SuperSeal
- left 7 pin + 4 x 2 pin SuperSeal Superpoint IV
- right 7 pin + 4 x 2 pin SuperSeal Superpoint IV



192		8
192		8
192		8
192		8
128		8
128		8

PART NO

25-4121-037
25-4120-037
25-4121-047
25-4120-047
25-4121-057
25-4120-057

ECOLED II TRUCK WITH 7 PIN AMP (DIN 72585) CONNECTION



DESCRIPTION

- left 7 pin
- right 7 pin



192		8
192		8

PART NO

25-4121-067
25-4120-067



*** ECOLED**

WITH 7 PIN ASS2 CONNECTION



ATTENTION!

long slot necessary

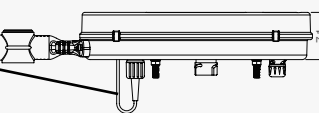
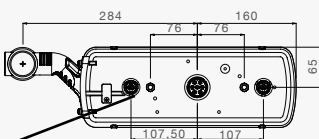
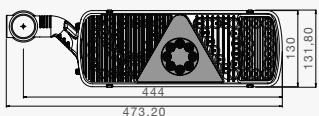
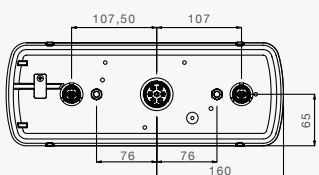
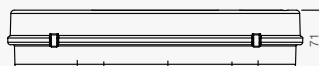
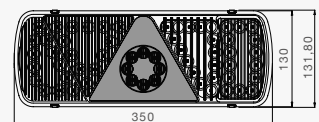
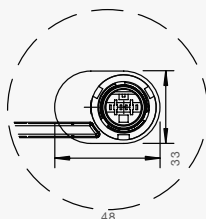

GENERAL DESCRIPTION

- New unique design with all functions in LED.
- Tight construction.
- Additional 2 x 2 pin ASS2 exits for additional options.
- Low current consumption.
- Trailer identification including (direction indicator monitoring) according to ECE 48 without additional tools.
- Integrated side marker light with reflector.
- With or without end outline marker.
- LCG function included for the direction indicator function.

DESCRIPTION

			PART NO
EcoLED - standard left	160	10	25-3800-507
EcoLED - standard right	160	10	25-3900-507
EcoLED - with 2 x ASS2 left	160	10	25-3800-517
EcoLED - with 2 x ASS2 right	160	10	25-3900-517
EcoLED - with outline marker and 2 x ASS2 left	96	6	25-3820-517
EcoLED - with outline marker and 2 x ASS2 right	96	6	25-3920-517

SPARE PARTS / ACCESSORIES ECOLED



DESCRIPTION

			PART NO
end outline marker LED left red/white/orange			31-3305-237
end outline marker LED right red/white/orange			31-3306-237
additional LCG 2 - EcoLED			75-0309-001

SPARE PARTS / ACCESSORIES ECOLED II



protection cap for rear lamp EcoLED II			25-7535-157
--	--	--	-------------



* EUROPOINT III LED

WITH 7 PIN ASS2.1 CONNECTION

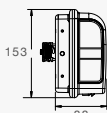
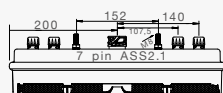
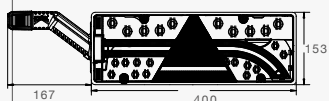
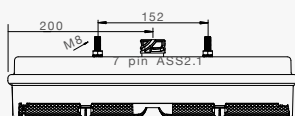
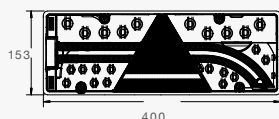

GENERAL DESCRIPTION

- The first lamp with a „light guide“ (= fiber optics, already known from the automotive industry) designed especially for heavy duty trailers.
- Opportunity for direct mounting of an additional flexible LED end outline marker lamp.
- Pre-wired with 7 pin central connection of Type Aspöck ASS2.1.
- 4 pcs additional 2 pin connectors on the rear of the lamp
- Dimensions 400 x 153 x 88 mm.

DESCRIPTION

			PART NO
left	120	10	25-7000-707
right	120	10	25-7400-707
left, including cross wiring outline marker Superpoint IV with integrated direction indicator LCG	96	8	25-7020-737
right, including cross wiring outline marker Superpoint IV with integrated direction indicator LCG	96	8	25-7420-767
left, 4 x 2 pin ASS2	120	10	25-7000-717
right, 4 x 2 pin ASS2	120	10	25-7400-717
left including cross wiring outline marker Superpoint IV	96	8	25-7020-707
right including cross wiring outline marker Superpoint IV	96	8	25-7420-707
left with integrated LCG direction indicator	120	10	25-7000-747
right with integrated LCG direction indicator	120	10	25-7400-747
left including cross wiring outline marker Superpoint IV, with 4 x 2 pin ASS2	96	8	25-7020-717
right including cross wiring outline marker Superpoint IV, with 4 x 2 pin ASS2	96	8	25-7420-717

SPARE PARTS / ACCESSORIES



DESCRIPTION

	PART NO
lens left as spare part	18-8570-001
lens right as spare part	18-8570-101
insert „Light guide“ left	12-1570-001
insert „Light guide“ right	12-1570-101
LED insert direction indicator left	12-1570-224
LED insert direction indicator right	12-1574-224
LED insert for stop light left	12-1570-204
LED insert for stop light right	12-1574-204
LED insert for reverse light left	12-1570-234
LED insert for reverse light right	12-1574-234
LED insert for fog light right	12-1574-214
LED insert for fog light left	12-1570-214
end outline marker left red/white/orange	31-3103-024
end outline marker right red/white/orange	31-3102-024

* please notice the general advice at page 84



EUROPOINT III

WITH 7 PIN ASS2.1 CONNECTION

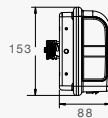
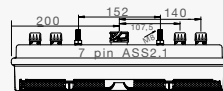
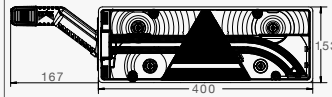
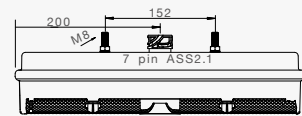
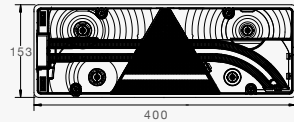

GENERAL DESCRIPTION

- The first lamp with a „light guide“ (= fiber optics, already known from the automotive industry) designed especially for heavy duty trailers.
- Opportunity for direct mounting of an additional flexible LED end outline marker lamp.
- Pre-wired with 7 pin central connection of Type Aspöck ASS2.1.
- 4 pcs additional 2 pin connectors on the rear of the lamp.
- Dimensions 400 x 153 x 88 mm.

DESCRIPTION

DESCRIPTION			PART NO
left	120	10	25-7000-507
right	120	10	25-7400-507
left, 4 x 2 pin ASS2	120	10	25-7000-517
right, 4 x 2 pin ASS2	120	10	25-7400-517
left including cross wiring outline marker Superpoint IV	96	8	25-7020-507
right including cross wiring outline marker Superpoint IV	96	8	25-7420-507
left including cross wiring outline marker Superpoint IV, with 4 x 2 pin ASS2	96	8	25-7020-517
right including cross wiring outline marker Superpoint IV, with 4 x 2 pin ASS2	96	8	25-7420-517

SPARE PARTS / ACCESSORIES



DESCRIPTION

DESCRIPTION	PART NO
lens left as spare part	18-8570-001
lens right as spare part	18-8570-101
insert „Light guide“ left	12-1570-001
insert „Light guide“ right	12-1570-101
LED insert direction indicator left	12-1570-224
LED insert direction indicator right	12-1574-224
LED insert for stop light left	12-1570-204
LED insert for stop light right	12-1574-204
LED insert for reverse light left	12-1570-234
LED insert for reverse light right	12-1574-234
LED insert for fog light right	12-1574-214
LED insert for fog light left	12-1570-214

EUROPOINT III TRUCK LED

WITH 7 PIN AMP CONNECTOR

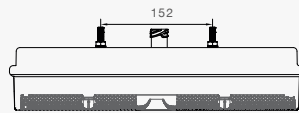

GENERAL DESCRIPTION

- Standardised lens for Europoint III Truck and Europoint III Trailer version.
- „Light Guide“ technology as a tail light.
- Conversion of bulb to maintenance-free LED modules possible.
- Dual chamber sealing system for increased jet water protection.
- Optional with 4 x 2-pin exits connectors available.

DESCRIPTION

left, 7 pin Amp, LED
right, 7 pin Amp, LED



120 | 10
120 | 10

PART NO

25-7000-757
25-7400-757

EUROPOINT III TRUCK

WITH 7 PIN AMP CONNECTOR

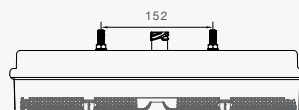

GENERAL DESCRIPTION

- Standardised lens for Europoint III Truck and Europoint III Trailer version.
- „Light Guide“ technology as a tail light.
- Conversion of bulb to maintenance-free LED modules possible.
- Dual chamber sealing system for increased jet water protection.
- Optional with 4 x 2-pin exits connectors available.

DESCRIPTION

left, 7 pin Amp, Bulb
right, 7 pin Amp, Bulb



120 | 10
120 | 10

PART NO

25-7000-547
25-7400-547



* EUROPOINT II LED

WITH 7 PIN ASS2 CONNECTOR

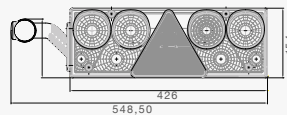
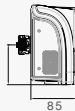
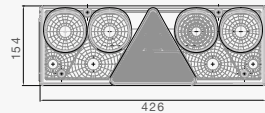

GENERAL DESCRIPTION

- Unique clear glass design.
- Number plate light option at the bottom.
- Option of 4 additional two pin connectors on the rear of the lamp for extra functions.
- Only one spare lens (for both sides).
- Easy modifying to LED.
- All functions in LED.

DESCRIPTION

- left tail light in LED
- left with NPL and tail light in LED
- right tail light in LED
- left with EOM lamp in LED r/w
- right with EOM lamp in LED r/w
- left all functions in LED except side marker lamp and position lamp
- left all functions and the EOM lamp are in LED r/w
- right all functions in LED except side marker lamps and position lamp
- right all functions and the EOM lamp are in LED r/w



PART NO

132		11	25-6000-707
132		11	25-6001-707
132		11	25-6400-707
108		9	25-6021-707
108		9	25-6421-707
132		11	25-6000-757
108		9	25-6020-757
108		9	25-6400-757
108		9	25-6420-757

SPARE PARTS / ACCESSORIES



LED insert tail light



LED Insert for direction indicator, reversing light, fog light and stop light



DESCRIPTION

- spare lens left and right usable
- EOM lamp left red/white in LED
- EOM lamp right red/white in LED
- LED insert for tail light
- LED insert for direction indicator
- LED insert for reverse
- LED insert for fog light
- LED insert for stop light



PART NO

18-8560-002
31-3305-084
31-3306-084
12-1560-001
12-1560-011
12-1560-021
12-1560-031
12-1560-141



EUROPOINT II

WITH 7 PIN ASS2 CONNECTOR

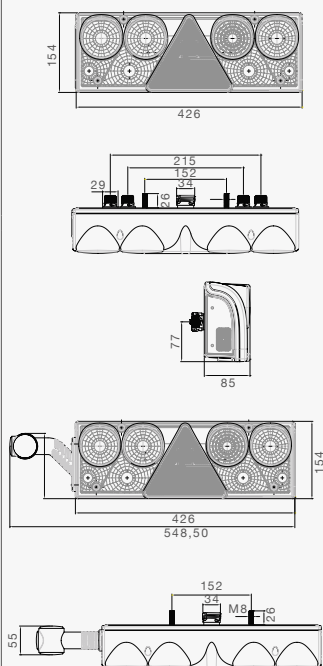

GENERAL DESCRIPTION

- Unique clear glass design.
- With and without number plate light to the bottom.
- Two bulbs for stop and tail light.
- Available with all functions in LED.
- Option of 4 additional 2 pin connectors of the rear side of the lamp for extra functions.
- Only one spare lens for left and right.
- Integrated side marker lamp.

DESCRIPTION

- left
- left with number plate light
- right
- right with number plate light
- left with additional 4 pieces 2 pin connections
- right with additional 4 pieces 2 pin connections
- left with end outline marker red/white
- right with end outline marker red/white



PART NO

132		11	25-6000-507
132		11	25-6001-507
132		11	25-6400-507
132		11	25-6401-507
132		11	25-6200-507
132		11	25-6600-507
108		9	25-6011-517
108		9	25-6411-517

SPARE PARTS AND ACCESSORIES



LED insert tail light

LED Insert for direction indicator, reversing light, fog light and stop light

DESCRIPTION

- Europoint II left as spare part
- Europoint II right as spare part
- Europoint II left with additional 4 pieces 2 pin connections as spare part
- Europoint II right with additional 4 pieces 2 pin connections as spare part
- left with end outline marker red/white as spare part
- right with end outline marker red/white as spare part
- spare lens Europoint II
- lens end outline marker red/white
- end outline marker left red/white
- end outline marker right red/white
- orange bulb for direction indicator
- bulb for end outline marker 24V 4W
- bulb 24V 10W
- bulb 24V 21W
- LED insert for tail light
- LED insert for direction indicator
- LED insert for reverse
- LED insert for fog light
- LED insert for stop light
- reverse beeper
- close connection
- protection cap small
- protection cap big

PART NO

25-6000-501
25-6400-501
25-6200-501
25-6600-501
25-6011-511
25-6411-511
18-8560-002
18-8141-004
31-3305-064
31-3306-064
16-6321-607
16-6304-007
16-6310-007
16-6321-007
12-1560-001
12-1560-011
12-1560-021
12-1560-031
12-1560-141
12-3922-014
15-5623-304
15-5270-004
15-5276-004

* ECOPOINT II LED

WITH 7 PIN ASS2 CONNECTOR

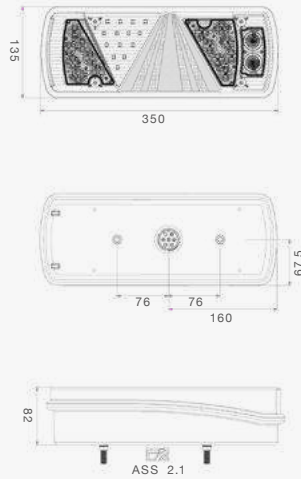

GENERAL DESCRIPTION

- New design.
- Integrated side marker light with reflector.
- Available end outline marker (in bulb version).
- Additional 2x 2 pin ASS2 exits for additional options.
- With or without number plate light.

DESCRIPTION

Ecopoint II full LED left
Ecopoint II full LED right



128 | 8
128 | 8

PART NO
25-2801-707
25-2901-707



* ECOPOINT II LED WITHOUT TRIANGLE

WITH 7 PIN ASS2 CONNECTOR

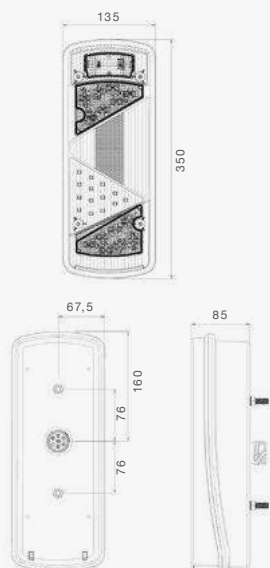

GENERAL DESCRIPTION

- without triangle
- mounting opportunity horizontal / vertical

DESCRIPTION

Ecopoint II full LED without triangle left
Ecopoint II full LED without triangle right



128 | 8
128 | 8

PART NO
25-2860-707
25-2960-707



ECOPOINT II

WITH 7 PIN ASS2 CONNECTOR

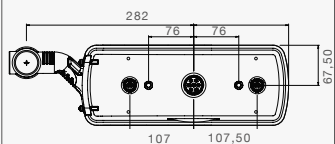
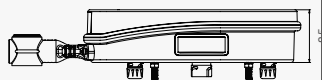
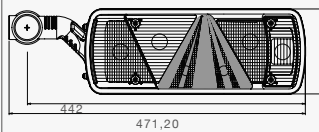
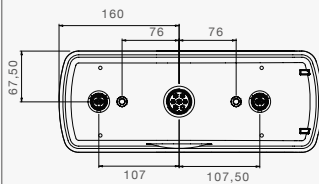
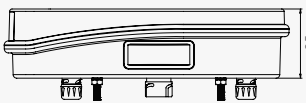
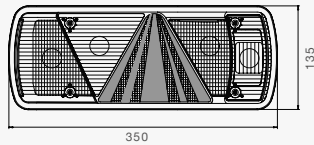

GENERAL DESCRIPTION

- New design with lighted triangle.
- Integrated side marker light with reflector.
- Available end outline marker (in bulb version).
- Additional 2x 2 pin ASS2 exits for additional options.
- With or without number plate light.

DESCRIPTION

- Ecopoint II standard left
- Ecopoint II standard right
- Ecopoint II with outline marker left
- Ecopoint II with outline marker right
- Ecopoint II with 2x ASS2 left
- Ecopoint II with 2x ASS2 right
- Ecopoint II with outline marker and 2x ASS2 left
- Ecopoint II with outline marker and 2x ASS2 right



128		8
128		8
96		6
96		6
128		8
128		8
96		6
96		6

PART NO
25-2800-507
25-2900-507
25-2810-507
25-2910-507
25-2800-517
25-2900-517
25-2810-517
25-2910-517

ECOPOINT II WITHOUT TRIANGLE

WITH 7 PIN ASS2 CONNECTOR

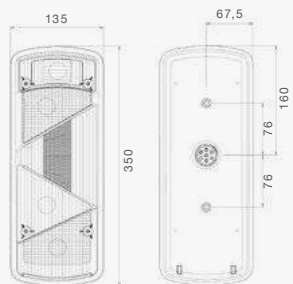

GENERAL DESCRIPTION

- without triangle
- mounting opportunity horizontal / vertical

DESCRIPTION

- Ecopoint II without triangle left
- Ecopoint II without triangle right



128		8
128		8

PART NO
25-2860-047
25-2960-047

SPARE PARTS / ACCESSORIES



DESCRIPTION

Ecopoint II standard left
 Ecopoint II standard right
 Ecopoint II with outline marker left
 Ecopoint II with outline marker right
 Ecopoint II with 2x ASS2 left
 Ecopoint II with 2x ASS2 right
 Ecopoint II with outline marker and 2x ASS2 left
 Ecopoint II with outline marker and 2x ASS2 right
 Ecopoint II left included LED insert at tail and stop light
 Ecopoint II right included LED insert at tail and stop light
 Ecopoint II with outline marker left included LED insert at tail and stop light
 Ecopoint II with outline marker right included LED insert at tail and stop light
 LED insert for tail+stop light left
 LED insert for tail+stop light right
 LED insert, reverse light, left
 LED insert, reverse light, right
 LED insert, direction indicator light, left
 LED insert, direction indicator light, right
 LED insert, fog light, left and right
 spare lense Ecopoint II left
 spare lense Ecopoint II right
 end outline marker, short left red/white/orange
 end outline marker, short right red/white/orange
 end outline marker, long left/right red/white/orange
 protection cap Ecopoint II
 bulb end outline marker 24V 4W
 bulb 24V 21W orange
 bulb 24V 10W
 bulb 24V 21W

PART NO

25-2800-501
 25-2900-501
 25-2810-501
 25-2910-501
 25-2800-511
 25-2900-511
 25-2810-511
 25-2910-511
 25-2800-451
 25-2900-451
 25-2810-451
 25-2910-451
 12-1528-001
 12-1529-001
 12-1522-144
 12-1526-144
 12-1522-154
 12-1526-154
 12-1526-164
 18-8528-002
 18-8529-002
 31-3303-027
 31-3302-027
 31-3302-104
 15-5277-007
 16-6304-007
 16-6321-607
 16-6310-007
 16-6321-007

*MULTILED II TAIL-STOP-DI-REVERSING-FOG-LAMP AND TRIANGLE REFLECTOR



VERSION FLAT WITHOUT NUMBERPLATE LIGHT

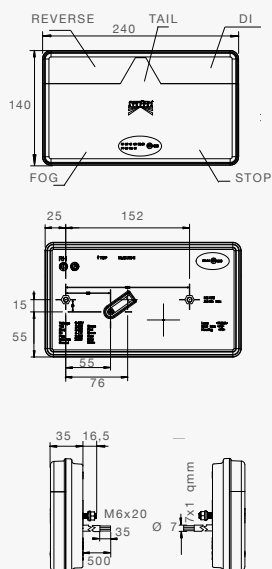

DESCRIPTION

left 0.5 m with open end cable
right 0.5 m with open end cable

left 0.5 m, 5 pin with bayonet without reverse
right 0.5 m, 5 pin with bayonet without fog

left 0.5 m, 8 pin with bayonet
right 0.5 m, 8 pin with bayonet

left 0.5 m, 7 pin ASS2
right 0.5 m, 7 pin ASS2

left 0.5 m, 7 pin AMP
right 0.5 m, 7 pin AMP



PART NO

320		20	35-0201-007
320		20	35-0202-007
320		10	35-0201-017
480		10	35-0202-017
320		10	35-0201-027
320		10	35-0202-027
320		10	35-0201-037
320		10	35-0202-037
320		10	35-0201-047
320		10	35-0202-047

VERSION DEEP WITHOUT NUMBER PLATE LIGHT

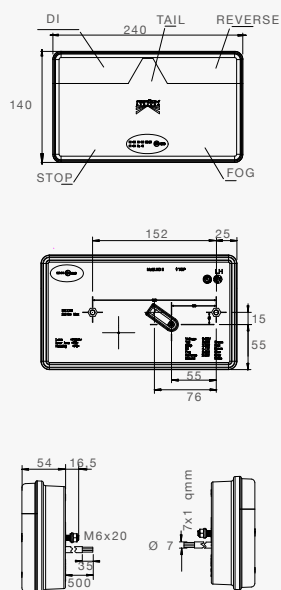

DESCRIPTION

left 0.5 m with open end cable
right 0.5 m with open end cable

left 0.5 m, 5 pin with bayonet without reverse
right 0.5 m, 5 pin with bayonet without fog

left 0.5 m, 8 pin with bayonet
right 0.5 m, 8 pin with bayonet

left 0.5 m, 7 pin ASS2
right 0.5 m, 7 pin ASS2

left 0.5 m, 7 pin AMP
right 0.5 m, 7 pin AMP



PART NO

240		20	35-0203-007
240		20	35-0204-007
320		10	35-0203-017
320		10	35-0204-017
320		10	35-0203-027
320		10	35-0204-027
320		10	35-0203-037
240		10	35-0204-037
240		20	35-0203-047
240		20	35-0204-047

* please notice the general advice at page 84

***MULTILED II TAIL-STOP-DI-REVERSING-FOG-LAMP AND TRIANGLE REFLECTOR**



VERSION DEEP INCLUDING NUMBERPLATE LIGHT

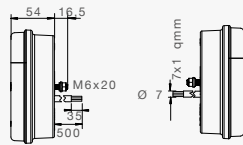
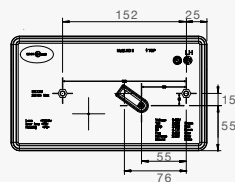
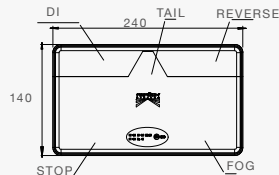

DESCRIPTION



PART NO

left + NPL 0.5 m with open end cable	240		20	35-0203-057
right + NPL 0.5 m with open end cable	240		20	35-0204-057
left + NPL below 0.5 m with open end cable	240		20	35-0203-107
right + NPL below 0.5 m with open end cable	240		20	35-0204-107
left + NPL 0.5 m, 5 pin with bayonet without reverse	320		10	35-0203-067
right + NPL 0.5 m, 5 pin with bayonet without fog	320		10	35-0204-067
left + NPL below 0.5 m, 5 pin with bayonet without reverse	336		12	35-0203-117
right + NPL below 0.5 m, 5 pin with bayonet without fog	336		12	35-0204-117
left + NPL 0.5 m, 8 pin with bayonet	320		10	35-0203-077
right + NPL 0.5 m, 8 pin with bayonet	320		10	35-0204-077
left + NPL below 0.5 m, 8 pin with bayonet	320		10	35-0203-127
right + NPL below 0.5 m, 8 pin with bayonet	320		10	35-0204-127
left + NPL 0.5 m, 7 pin ASS2	320		10	35-0203-087
right + NPL 0.5 m, 7 pin ASS2	320		10	35-0204-087
left + NPL below 0.5 m, 7 pin ASS2	336		12	35-0203-137
right + NPL below 0.5 m, 7 pin ASS2	336		12	35-0204-137
left + NPL 0.5 m, 7 pin AMP	336		12	35-0203-097
right + NPL 0.5 m, 7 pin AMP	336		12	35-0204-097
left + NPL below 0.5 m, 7 pin AMP	336		12	35-0203-147
right + NPL below 0.5 m, 7 pin AMP	336		12	35-0204-147



* MULTILED

WITH 7 PIN ASS2 MALE CONNECTOR

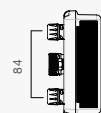
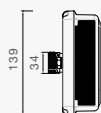
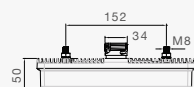
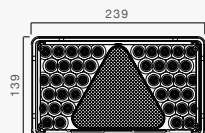

GENERAL DESCRIPTION

- With all functions in LED (reversing light, stop light, direction indicator and fog light).
- Integrated electronics for power control and trailer identification.
- With or without side marker lamps in led.
- With or without triangle.
- With or without 2 pin ASS2 connection.

DESCRIPTION

- MultiLED with triangle left, with SML, with LCG
- MultiLED with triangle right, with SML, with LCG
- MultiLED with triangle left, 2 x 2 pin ASS2 connection, with SML, with LCG
- MultiLED with triangle right, 2 x 2 pin ASS2 connection, with SML, with LCG



PART NO

- 24-7400-707
- 24-7500-707
- 24-7401-707
- 24-7501-707

SPARE PARTS / ACCESSORIES

DESCRIPTION

- MultiLED with triangle left, with SML, with LCG as spare part
- MultiLED with triangle right, with SML, with LCG as spare part

PART NO

- 24-7400-701
- 24-7500-701

WITH 7 PIN DIN72585 AMP CONNECTOR

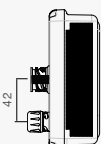
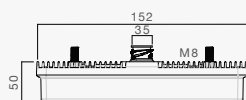
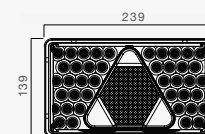
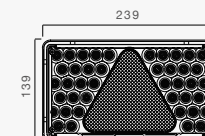
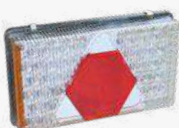

DESCRIPTION

- MultiLED with triangle left, with SML, with LCG, 1 x 2 pin ASS2 connection
- MultiLED with triangle right, with SML, with LCG 1 x 2 pin ASS2 connection
- MultiLED with triangle left, with SML, without LCG, 1 x 2 pin ASS2 connection
- MultiLED with triangle right, with SML, without LCG 1 x 2 pin ASS2 connection
- MultiLED without triangle left, with SML, with LCG, 1 x 2 pin ASS2 connection
- MultiLED without triangle right, with SML, with LCG 1 x 2 pin ASS2 connection



PART NO

- 24-7430-707
- 24-7530-707
- 24-7630-707
- 24-7730-707
- 24-7470-707
- 24-7570-707

* please notice the general advice at page 84



MULTIPOINT V LED

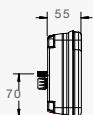
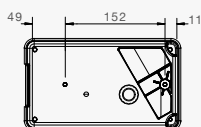
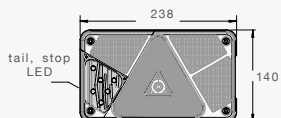

GENERAL DESCRIPTION

- Compact rear combination lamp with cable glands.
- Vibration free.
- Features LED applications: tail and stop light.
- Function bulb: direction indicator, reverse and fog light.
- Replaced Multipoint LED.

DESCRIPTION

Multipoint V LED with cable glands left

Multipoint V LED with cable glands right



480 | 24

480 | 24

PART NO

24-8504-717

24-8714-717

SPARE PARTS / ACCESSORIES



DESCRIPTION

Multipoint V LED left as spare part

Multipoint V LED right as spare part

lens Multipoint V LED left

lens Multipoint V LED right

LED insert for tail+stop light left



LED insert for tail+stop light right



Bulb 24V 5W

Bulb 24V 10W

Bulb 24V 21W

Bulb 24V 21/5W



PART NO

24-8504-701

24-8714-701

18-8485-007

18-8487-007

12-1530-004

12-1531-004

16-6305-007

16-6310-007

16-6321-007

16-6322-007

24V LAMPS REAR LAMPS

* MINILED II

DIRECTION INDICATOR-STOP-TAIL-FOG-REVERSE LAMP UNIVERSAL MOUNT



DIRECTION INDICATOR-STOP-TAIL LAMP

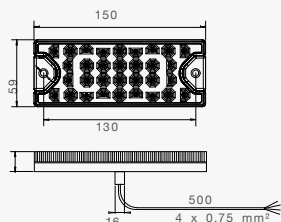
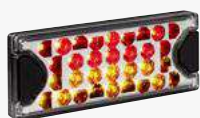

DESCRIPTION

0,5 m open end cable
0,5 m with 7 pin ASS2 +
0,25 m 3 pin ASS3
0,5 m with 8 pin bayonet +
0,25 m 3 pin ASS3



PART NO

33-7200-007
33-7207-007
33-7207-517

FOG-REVERSE LAMP

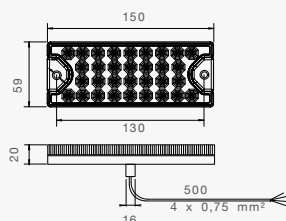

DESCRIPTION

0,5 m open end cable
0,5 m with 3 pin ASS3



PART NO

32-7200-007
32-7207-007

REVERSE LAMP

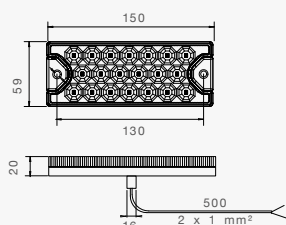

DESCRIPTION

0,5 m open end cable
0,5 m with 2 pin ASS3



PART NO

38-7200-007
38-7207-007

FOG LAMP

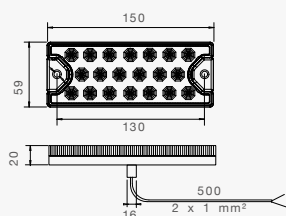

DESCRIPTION

0,5 m open end cable
0,5 m with 2 pin ASS3



PART NO

37-7200-007
37-7207-007

SPARE PARTS AND ACCESSORIES

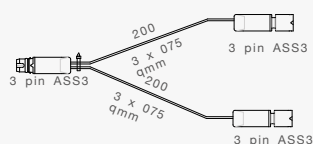

DESCRIPTION

Y-cable 3 pin ASS3



PART NO

65-6502-017

* please notice the general advice at page 84

LINEPOINT II SINGLE RESP. DOUBLE FUNCTION LAMP

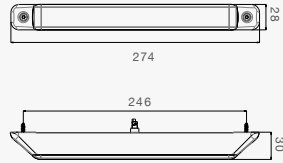

DESCRIPTION

tail light + stop, 0.5 m open end cable
360° Homologation

direction indicator, 0.5 m open end cable,
360° Homologation

fog, 0.5 m open end cable,
360° Homologation

reverse, 0.5 m open end cable, vertical

reverse, 0.5 m cable open end cable, horizontal



PART NO

31-9230-007

31-9231-007

37-9230-007

38-9230-007

38-9231-007

NEW: PROGRESSIVE DIRECTION INDICATOR FOR BETTER TURN SIGNAL VISIBILITY



DESCRIPTION

„progressive direction indicator“ left 0.5 m open end cable

„progressive direction indicator“ right 0.5 m open end cable

PART NO

31-9231-207

31-9231-217

LINEPOINT I LED SINGLE, DOUBLE RESP. TRIPLE FUNCTION LAMP

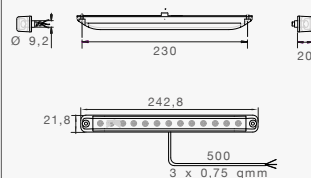

DESCRIPTION

tail light and stop, 0.5 m open end cable
horizontal/vertical

direction indicator, 0.5 m open end cable
horizontal/vertical

fog, 0.5 m open end cable
horizontal/vertical

reverse, 0.5 m, open end cable, horizontal/vertical

3rd stop lamp, 0.5 m, open end cable,
horizontal/vertical

tail light, stop light and direction indicator, 0.5 m, open end cable horizontal/vertical

tail light, stop light and direction indicator, 5 m, open end cable horizontal/vertical



PART NO

31-9220-007

31-9221-007

37-9220-007

38-9220-007

31-8920-007

33-8914-007

33-8914-017

24V LAMPS REAR LAMPS

SINGLE RESP. DOUBLE FUNCTION LAMP



WITH ASS3 CONNECTOR

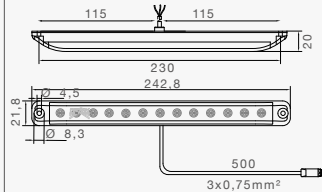

DESCRIPTION

tail light + stop light horizontal/vertical 0,5m ASS3

direction indicator horizontal/vertical 0,5m ASS3

NSL horizontal/vertical 0,5m ASS3

RFS horizontal/vertical 0,5m ASS3



PART NO

31-9207-047

31-9207-057

37-9207-017

38-9207-017

SMARTLINK - ASS3 FOR LINEPOINT I & LINEPOINT II

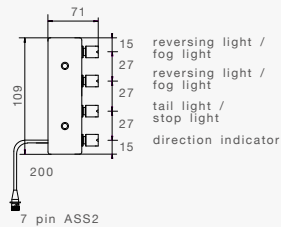
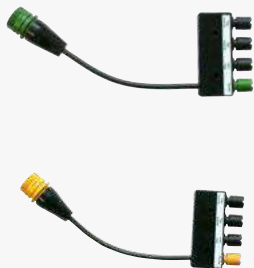

DESCRIPTION

junction box right 0.2 m, IN: 7 pin ASS2, OUT: 4 x ASS3

junction box left 0.2 m, IN: 7pin ASS2, OUT: 4 x ASS3



PART NO

76-9028-007

76-9027-007

SPARE PARTS / ACCESSORIES

DESCRIPTION

rubber pad horizontal/vertical



PART NO

15-5111-407

BRASPOINT 98 MM 



TAIL, STOP AND DIRECTION INDICATOR

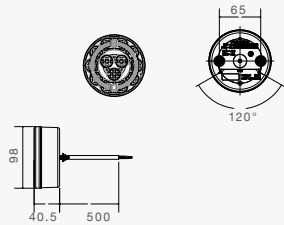

DESCRIPTION

0.5 m with open end cable



PART NO

33-9200-007

TAIL, FOG AND REVERSE LAMP HORIZONTAL

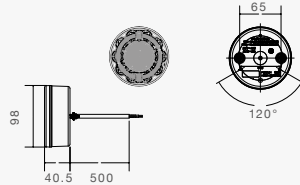

DESCRIPTION

0.5 m with open end cable



PART NO

33-8100-107

TAIL, FOG AND REVERSE LAMP VERTICAL

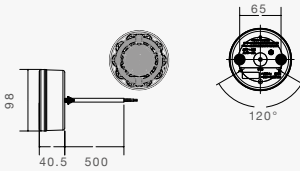

DESCRIPTION

0.5 m with open end cable



PART NO

33-8100-007

BRASPOINT 140 MM 



TAIL, STOP AND DIRECTION INDICATOR

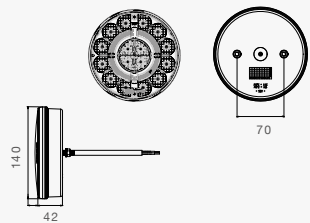

DESCRIPTION

0.5 m with open end cable



PART NO

33-9200-207

TAIL, FOG AND REVERSE LAMP

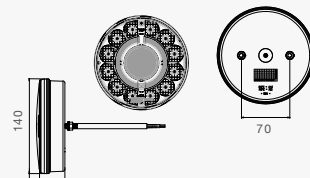

DESCRIPTION

0.5 m with open end cable



PART NO

33-8100-207

24V LAMPS REAR LAMPS

BRASPOINT 140 MM

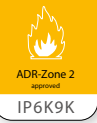

STOP AND TAIL LAMP

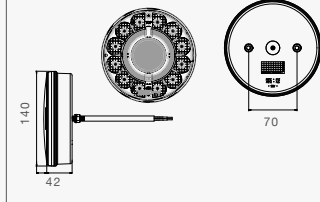

DESCRIPTION

0.5 m with open end cable



PART NO

33-9200-307

2 POSSIBILITIES OF MOUNTING FOR BRASPOINT 140 MM LAMPS

VERSION 1

2 pieces Braspoint 140 tail, fog, reverse
7 pin ASS2 connector

33-8107-037

2 pieces Braspoint 140 tail, stop, direction indicator
2 x 7 pin ASS2 connector

33-9207-067

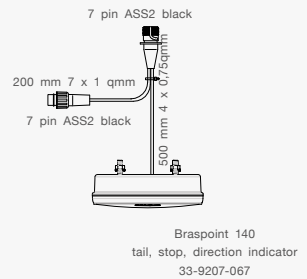
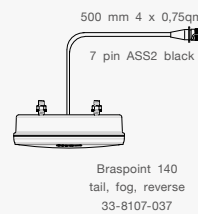
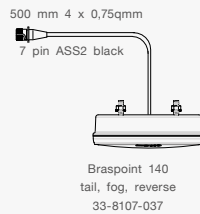
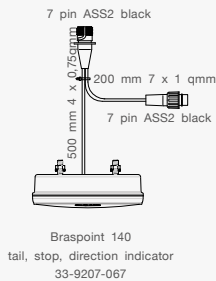

VERSION 2

2 pieces Braspoint 140 tail, fog, reverse
7 pin ASS2 connector

33-8107-037

2 pieces Braspoint 140 tail, stop, direction indicator
2 x 7 pin ASS2 connector

33-9207-067

2 pieces Braspoint 140 tail, stop
2 x 7 pin ASS2 connector

33-9207-077

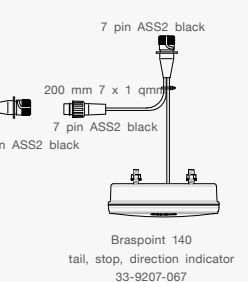
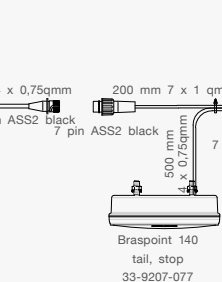
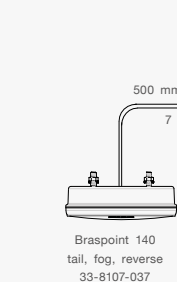
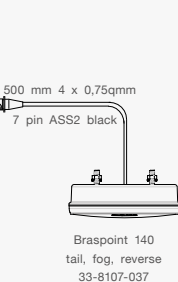
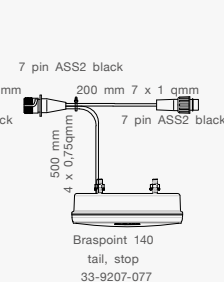
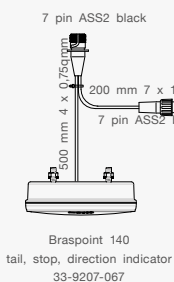



*** 3 CHAMBER LAMP LED**

3 CHAMBER LAMP LED, DOUBLE FUNCTION D= 140 MM (2 x TAIL LAMP, 2 x STOP LAMP)

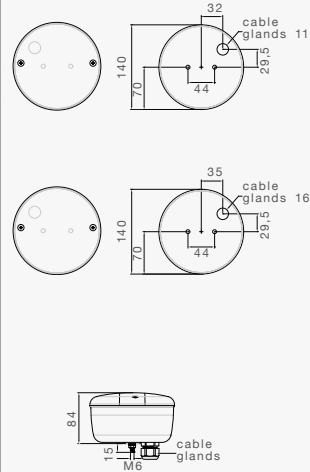

GENERAL DESCRIPTION

- with tail light, stop light and direction indicator

DESCRIPTION

- with cable glands 11
- with cable glands 16
- left with 0,5 m cable, open end
- right with 0,5 m cable, open end
- left with 0,5 m cable and 7 pin ASS2 connection
- right with 0,5 m cable and 7 pin ASS2 connection



PART NO
23-8400-757
23-8400-767
33-8403-037
33-8402-037
33-8405-087
33-8406-087

3 CHAMBER LAMP LED, SINGLE FUNCTION D= 140 MM (1 x TAIL LAMP, 1 x STOP LAMP)

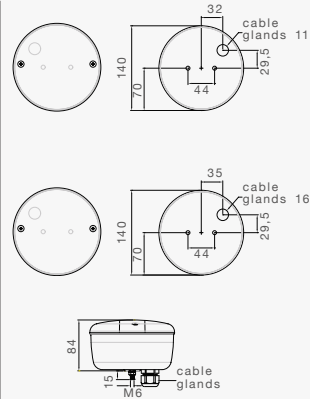

DESCRIPTION

- with cable glands 11
- with cable glands 16
- left with 0,5 m cable, open end
- right with 0,5 m cable, open end
- left with 0,5 m cable and 7 pin ASS2 connection
- right with 0,5 m cable and 7 pin ASS2 connection



PART NO
23-8400-807
23-8400-817
33-8403-047
33-8402-047
33-8405-097
33-8406-097

FOG LAMP LED D= 140 MM

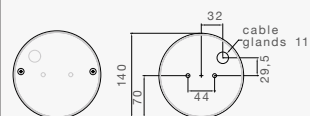

DESCRIPTION

- with cable glands 11
- with 1,5 m cable and 2 pin ASS2 connection
- with 0,15 m cable and 7 pin ASS2 connection



PART NO
27-8400-707
37-8407-007
37-8407-017

24V LAMPS REAR LAMPS

REVERSE LAMP LED D=140 MM

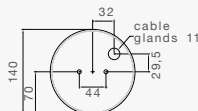

DESCRIPTION

with cable glands 11
with 1,5 m cable, and
2 pin ASS2 connector
with 0,15 m cable and 7 pin
ASS2 connector



PART NO
28-8400-707
38-8407-007
38-8107-067

FOG-REVERSE LAMP COMBINED LED D=140 MM

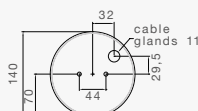

DESCRIPTION

with cable glands 11
with 1,5 m cable, and
7 pin ASS2 connection



PART NO
22-7000-707
32-7000-707

SPARE PARTS AND ACCESSORIES



DESCRIPTION

3 chamber lamp LED, double
function with cable glands 11

3 chamber lamp LED, double
function with cable glands 16

3 chamber lamp LED,
single function with cable
glands 11

3 chamber lamp LED,
single function with cable
glands 16

fog lamp LED with cable
glands 11

reverse lamp LED with cable
glands 11

fog-reverse lamp with cable
glands 11

PART NO
23-8400-751
23-8400-761
23-8400-801
23-8400-811
27-8400-701
28-8400-701
22-7000-701

2 VARIANTS OF 3 CHAMBER LAMP KIT

VARIANT 1

2 pieces 3 chamber lamp LED,
2 x 7 pin ASS2 connector

33-8407-017

2 pieces fog-reverse lamp combined LED
7 pin ASS2 connector

39-7007-007

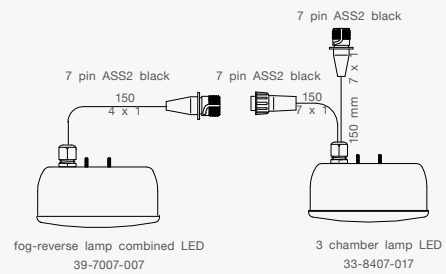
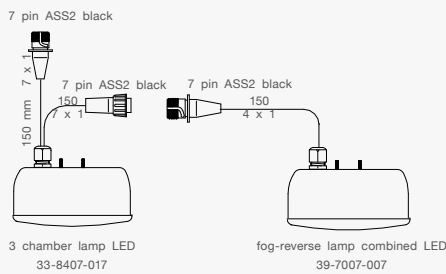

VARIANT 2

4 pieces 3 chamber lamp LED,
2 x 7 pin ASS 2 connector

33-8407-017

2 pieces fog-reverse lamp combined LED
7 pin ASS 2 connector

39-7007-007

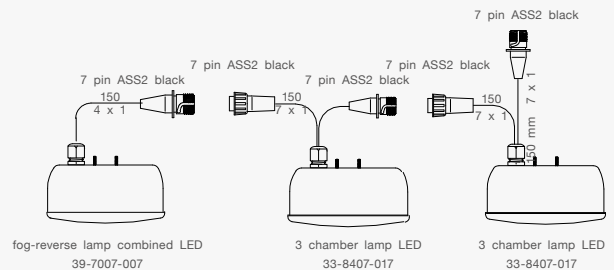
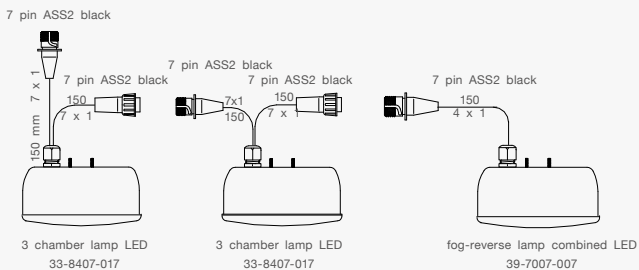

ADDITIONAL INFO

- Only at the single function lamps is a double mounting allowed by law (1 x stop lamp and 1 x tail lamp).
- By double mounting of 3 chamber lamps with Aspöck harnesses is the cross wiring included.



3 CHAMBER LAMP

3 CHAMBER LAMP D= 140 MM

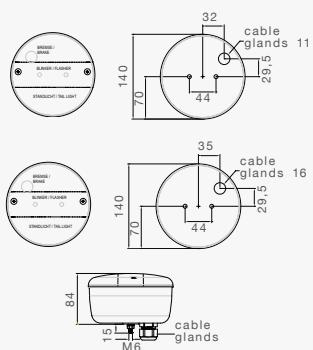

GENERAL DESCRIPTION

- with tail lamp, stop lamp and direction indicator

DESCRIPTION

- with 8 pin bajonet-connection
- with cable glands 11
- with cable glands 16



PART NO

- 23-8200-517
- 23-8200-017
- 23-8230-007

FOG LAMP D= 140 MM

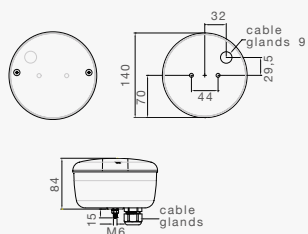

DESCRIPTION

- with cable glands 9
- with 0,25 m cable ASS2 connection



PART NO

- 27-8000-027
- 37-8007-157

REVERSING LAMP D= 140 MM

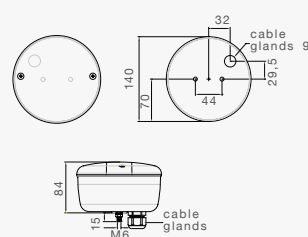

DESCRIPTION

- with cable glands 9
- with 0,25 m with cable and 2 pin ASS2 connection



PART NO

- 28-8000-027
- 38-8007-167

SPARE PARTS / ACCESSORIES



DESCRIPTION

- 3 chamber lamp with cable glands 11 as spare part
- rear fog lamp with cable glands 9 as spare part
- reversing lamp with cable glands 9 as spare part
- lens 3 chamber rear light with screws
- lens fog lamp with screws
- lens reversing lamp with screws
- bulb 24V 21W
- bulb 24V 5W



PART NO

- 23-8200-011
- 27-8000-021
- 28-8000-021
- 18-8382-107
- 18-8780-107
- 18-8880-107
- 16-6321-007
- 16-6305-007

24V LAMPS POSITION LAMPS



FLATPOINT II WHITE LED

SURFACE MOUNT VERSION WITH REFLECTOR AND P&R CONNECTION

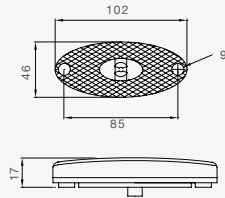

GENERAL DESCRIPTION

- LED position lamp.
- High light output with low current consumption.
- Direct cable exit on the backside of the lamp.

DESCRIPTION

- with 0,5 m cable
- with 1,5 m cable
- with 3,5 m cable



PART NO

- 31-6904-017
- 31-6904-037
- 31-6904-057

ATTENTION!!!

CAP FOR P&R CONNECTOR IS NOT INCLUDED ANY MORE - PLEASE ORDER IN ADDITION, PART NO 15-5971-007

DUAL VOLTAGE



DESCRIPTION

- with 1,5 m cable



PART NO

- 31-6904-167

SURFACE MOUNT VERSION WITHOUT REFLECTOR AND P&R CONNECTION

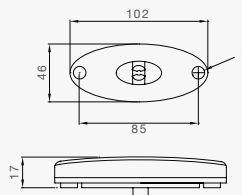

DESCRIPTION

- with 3,5 m cable



PART NO

- 31-6904-127

SURFACE MOUNT VERSION WITH REFLECTOR AND OPEN END



DESCRIPTION

- with 0,5 m cable



PART NO

- 31-6900-017

ATTENTION!!!

CAP FOR P&R CONNECTOR IS NOT INCLUDED ANY MORE - PLEASE ORDER IN ADDITION, PART NO 15-5971-007

SURFACE MOUNT VERSION WITH REFLECTOR AND 3 PIN ASS3



DESCRIPTION

- with 0,5 m cable
- with 1,5 m cable



PART NO

- 31-6907-027
- 31-6907-037



FLATPOINT II RED LED

SURFACE MOUNT VERSION WITH REFLECTOR AND P&R CONNECTION

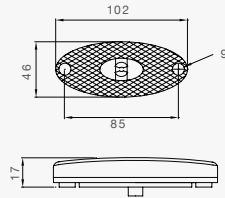

GENERAL DESCRIPTION

- LED position lamp.
- High light output with low current consumption.
- Direct cable exit on the backside of the lamp.

DESCRIPTION

with 0,5 m cable



PART NO

31-6404-017

ATTENTION!!!

CAP FOR P&R CONNECTOR IS NOT INCLUDED ANY MORE - PLEASE ORDER IN ADDITION, PART NO 15-5971-007

SURFACE MOUNT VERSION WITHOUT REFLECTOR AND P&R CONNECTION

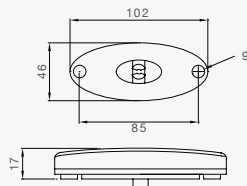

DESCRIPTION

with 0,5 m cable
with 3,5 m cable



PART NO

31-6404-097
31-6404-127

ATTENTION!!!

CAP FOR P&R CONNECTOR IS NOT INCLUDED ANY MORE - PLEASE ORDER IN ADDITION, PART NO 15-5971-007

SPARE PARTS / ACCESSORIES



DESCRIPTION

rubber pad
fixation 90° to the front
fixation 90° to the back
straight bracket
screws for angle (1 pc)
cap for P&R connector



PART NO

15-5111-007
15-5321-107
15-5321-207
15-5321-007
14-0418-307
15-5971-007



UNIPOINT I WHITE LED

WITH REFLECTOR AND P&R CONNECTION

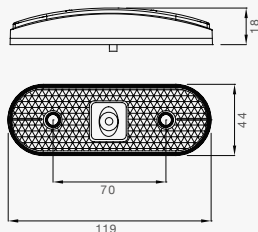

GENERAL DESCRIPTION

- LED position lamp.
- High light output with low current consumption.
- Direct cable exit on the backside of the lamp.

DESCRIPTION

- with 0,5 m cable
- with 1,5 m cable
- with 3,5 m cable



PART NO

- 31-7704-017
- 31-7704-037
- 31-7704-057

ATTENTION!!!

CAP FOR P&R CONNECTOR IS NOT INCLUDED ANY MORE - PLEASE ORDER IN ADDITION, PART NO 15-5971-007

WITHOUT REFLECTOR AND P&R CONNECTION

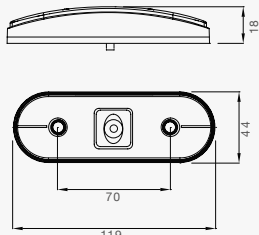

DESCRIPTION

- with 0,5 m cable
- with 3,5 m cable



PART NO

- 31-7704-097
- 31-7704-127

ATTENTION!!!

CAP FOR P&R CONNECTOR IS NOT INCLUDED ANY MORE - PLEASE ORDER IN ADDITION, PART NO 15-5971-007

WITH REFLECTOR AND 2 X 1,5 MM² FLAT CABLE FOR P&R CONNECTION



DESCRIPTION

- with 1,0 m cable



PART NO

- 31-7704-077

WITHOUT REFLECTOR AND 2 X 1,5 MM² FLAT CABLE FOR P&R CONNECTION



DESCRIPTION

- with 4,0 m cable



PART NO

- 31-7704-087

WITH REFLECTOR AND 3 PIN ASS3 CONNECTION



DESCRIPTION

with 0,5 m cable
with 1,5 m cable



PART NO

31-7707-107
31-7707-117

WITHOUT REFLECTOR AND 3 PIN ASS3 CONNECTION



DESCRIPTION

3,5 m cable



PART NO

31-7707-127

UNIPOINT I WHITE VERTICAL WITH REFLECTOR



DESCRIPTION

Vertical version with 1,5 m
P&R



PART NO

31-7704-227

ATTENTION!!!

CAP FOR P&R CONNECTOR IS NOT INCLUDED ANY MORE - PLEASE ORDER IN ADDITION, PART NO 15-5971-007

SPARE PARTS / ACCESSORIES



DESCRIPTION

fixation 90° to the back
straight fixation
sloping angle to the back
sloping angle to the front
expanding rivet for lamp 14-15mm
cap for P&R connector



PART NO

15-5319-007
15-5317-007
15-5317-017
15-5319-307
14-4596-007
15-5971-007



UNIPOINT I RED LED

WITH REFLECTOR AND P&R CONNECTION

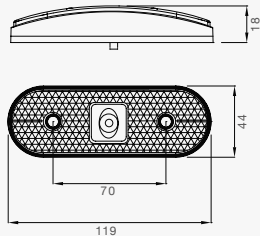

GENERAL DESCRIPTION

- LED position lamp.
- High light output with low current consumption.
- Direct cable exit on the backside of the lamp.

DESCRIPTION

with 0,5 m cable
with 3,5 m cable



PART NO

31-7804-017
31-7804-057

WITHOUT REFLECTOR AND P&R CONNECTION

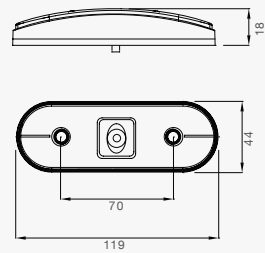

DESCRIPTION

with 0,5 m cable
with 3,5 m cable



PART NO

31-7804-097
31-7804-127

ATTENTION!!!

CAP FOR P&R CONNECTOR IS NOT INCLUDED ANY MORE - PLEASE ORDER IN ADDITION, PART NO 15-5971-007

WITH REFLECTOR AND FLAT CABLE 2 X 1,5 MM² FOR P&R CONNECTOR



DESCRIPTION

with 1 m flat cable



PART NO

31-7804-077

ATTENTION!!!

CAP FOR P&R CONNECTOR IS NOT INCLUDED ANY MORE - PLEASE ORDER IN ADDITION, PART NO 15-5971-007

WITHOUT REFLECTOR AND FLAT CABLE 2 X 1,5 MM² FOR P&R CONNECTOR



DESCRIPTION

with 4 m flatcable



PART NO

31-7804-087



POSIPOINT II WHITE LED

WITH OPEN END

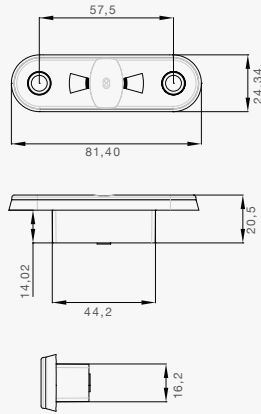

GENERAL DESCRIPTION

- LED position lamp.
- Optional housing available.
- Voltage span: 12V and 24V.

DESCRIPTION

- with 0,5 m cable
- with 3,5 m cable
- with 5,0 m cable



PART NO

- 31-7100-067
- 31-7100-017
- 31-7100-007

WITH P&R CONNECTION

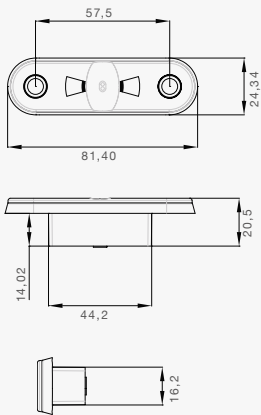

DESCRIPTION

- with 0,5 m cable
- with 1,5 m cable
- with 3,5 m cable



PART NO

- 31-7104-007
- 31-7104-017
- 31-7104-027

ATTENTION!!!

CAP FOR P&R CONNECTOR IS NOT INCLUDED ANY MORE - PLEASE ORDER IN ADDITION, PART NO 15-5971-007

SPARE PARTS / ACCESSORIES



DESCRIPTION

- housing for Posipoint II
- cap for P&R connector



PART NO

- 15-5609-107
- 15-5971-007

24V LAMPS POSITION LAMPS



POSIPOINT II RED LED

WITH OPEN END

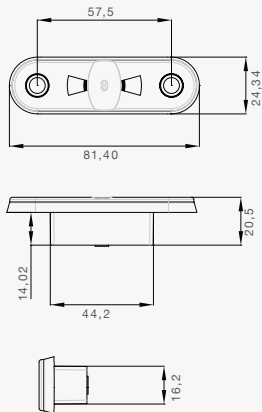

GENERAL DESCRIPTION

- LED position lamp.
- Optional housing available.
- Voltage span: 12V and 24V.

DESCRIPTION

- with 0,5 m cable
- with 3,5 m cable
- with 5,0 m cable



PART NO
 31-7200-067
 31-7200-017
 31-7200-007

WITH P&R CONNECTION

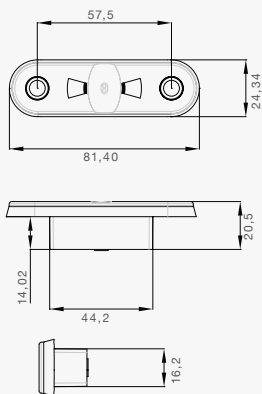

DESCRIPTION

- with 0,5 m cable
- with 1,5 m cable
- with 3,5 m cable



PART NO
 31-7204-007
 31-7204-017
 31-7204-027

ATTENTION!!!

CAP FOR P&R CONNECTOR IS NOT INCLUDED ANY MORE - PLEASE ORDER IN ADDITION, PART NO 15-5971-007

SPARE PARTS / ACCESSORIES



DESCRIPTION

- housing for Posipoint II
- cap for P&R connector



PART NO
 15-5609-107
 15-5971-007



MONOPOINT II WHITE LED 

SLIM, WITH P&R CONNECTION

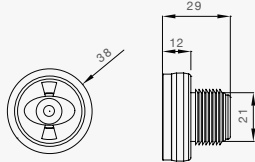

GENERAL DESCRIPTION

- LED position lamp.
- Optional housing available.
- Voltage span: 12V and 24V.

DESCRIPTION

- with 0,5 m cable
- with 1,5 m cable
- with 3,5 m cable



PART NO
31-6704-067
31-6704-077
31-6704-087

ATTENTION!!!

CAP FOR P&R CONNECTOR IS NOT INCLUDED ANY MORE - PLEASE ORDER IN ADDITION, PART NO 15-5971-007

SLIM, WITH OPEN END



DESCRIPTION

- with 3,5 m cable



PART NO
31-6700-027

DEEP, WITH P&R CONNECTION

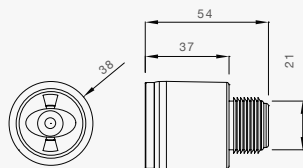

DESCRIPTION

- with 0,5 m cable
- with 1,5 m cable
- with 3,5 m cable



PART NO
31-6704-097
31-6704-107
31-6704-117

ATTENTION!!!

CAP FOR P&R CONNECTOR IS NOT INCLUDED ANY MORE - PLEASE ORDER IN ADDITION, PART NO 15-5971-007

DEEP, WITH OPEN END



DESCRIPTION

- with 3,5 m cable



PART NO
31-6700-037

24V LAMPS POSITION LAMPS



MONOPOINT II RED LED

SLIM, WITH P&R CONNECTION

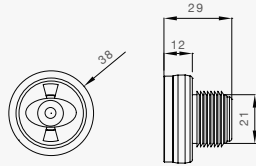

GENERAL DESCRIPTION

- LED position lamp.
- Optional housing available.
- Voltage span: 12V and 24V.

DESCRIPTION

- with 0,5 m cable
- with 3,5 m cable
- with 5,0 m cable



PART NO
 31-6804-087
 31-6804-067
 31-6804-097

ATTENTION!!!

CAP FOR P&R CONNECTOR IS NOT INCLUDED ANY MORE - PLEASE ORDER IN ADDITION, PART NO 15-5971-007

SLIM, WITH OPEN END



DESCRIPTION

- with 3,5 m cable



PART NO
 31-6800-017

DEEP, WITH P&R CONNECTION

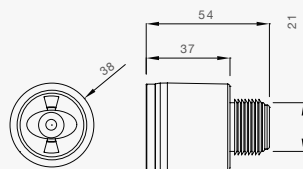

DESCRIPTION

- with 3,5 m cable



PART NO
 31-6804-077

ATTENTION!!!

CAP FOR P&R CONNECTOR IS NOT INCLUDED ANY MORE - PLEASE ORDER IN ADDITION, PART NO 15-5971-007

DEEP, WITH OPEN END



DESCRIPTION

- with 3,5 m cable



PART NO
 31-6800-027

SIDE MARKER LAMPS

FLATPOINT I LED



SURFACE MOUNT VERSION WITH P&R CONNECTION

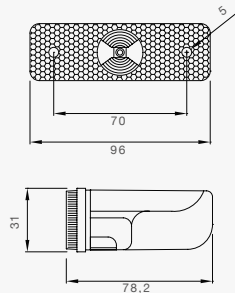

GENERAL DESCRIPTION

- With reflector.
- High light output with low current consumption.
- Flat lens.

DESCRIPTION

- with 0,5 m cable
- with 1,0 m cable
- with 1,5 m cable



PART NO

- 31-2214-117
- 31-2214-127
- 31-2214-137

ATTENTION!!!

CAP FOR P&R CONNECTOR IS NOT INCLUDED ANY MORE - PLEASE ORDER IN ADDITION, PART NO 15-5971-007

FIXATION 90° TO THE FRONT WITH P&R CONNECTION

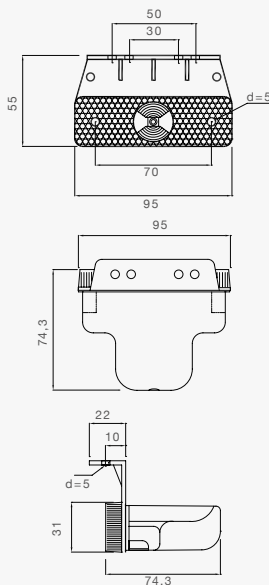

DESCRIPTION

- with 0,5 m cable
- with 1,0 m cable
- with 1,5 m cable



PART NO

- 31-2214-017
- 31-2214-027
- 31-2214-037

ATTENTION!!!

CAP FOR P&R CONNECTOR IS NOT INCLUDED ANY MORE - PLEASE ORDER IN ADDITION, PART NO 15-5971-007

FIXATION 90° WITH SLOPING BRACKET TO THE BACK AND P&R CONNECTION

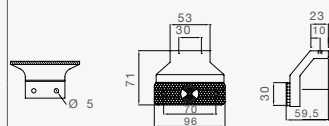

DESCRIPTION

- with 0,5 m cable
- with 1,0 m cable
- with 1,5 m cable



PART NO

- 31-2264-017
- 31-2264-027
- 31-2264-037

ATTENTION!!!

CAP FOR P&R CONNECTOR IS NOT INCLUDED ANY MORE - PLEASE ORDER IN ADDITION, PART NO 15-5971-007

24V LAMPS SIDE MARKER LAMPS

SPARE PARTS / ACCESSORIES



DESCRIPTION

loose lens, screws included
 complete lamp with protection cap and connection
 complete lamp with angle and connection
 angled connection 90° complete
 angled sloping connection 90° complete
 straight connection complete
 cap for P&R connector



PART NO

21-2200-004
 21-2201-004

 21-2200-014

 15-2122-104
 15-2128-144

 15-2122-124
 15-5971-007

FLATPOINT II LED



SURFACE MOUNT VERSION WITH P&R CONNECTION

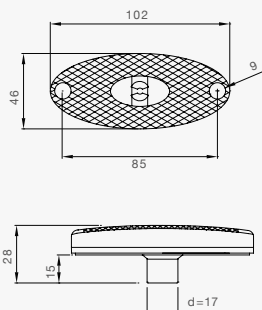

GENERAL DESCRIPTION

- With reflector.
- High light output with low current consumption.
- Direct cable exit on the backside of the lamp.
- Flat lens.

DESCRIPTION

with 0,5 m cable
 with 1,5 m cable



PART NO

31-2304-017
 31-2304-037

ATTENTION!!!

CAP FOR P&R CONNECTOR IS NOT INCLUDED ANY MORE - PLEASE ORDER IN ADDITION, PART NO 15-5971-007

DUAL VOLTAGE

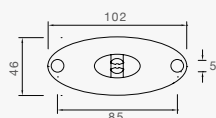

DESCRIPTION

with 1,5 m cable



PART NO

31-2304-097

FIXATION 90° FRONT AND P&R CONNECTION

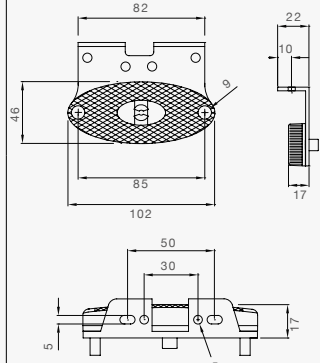

DESCRIPTION

with 0,5 m cable
with 1,5 m cable



PART NO
31-2364-017
31-2364-037

ATTENTION!!!

CAP FOR P&R CONNECTOR IS NOT INCLUDED ANY MORE - PLEASE ORDER IN ADDITION, PART NO 15-5971-007

FIXATION 90° BACK AND P&R CONNECTION

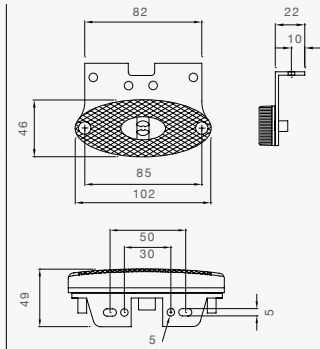

DESCRIPTION

with 0,5 m cable
with 1,5 m cable



PART NO
31-2364-087
31-2364-107

ATTENTION!!!

CAP FOR P&R CONNECTOR IS NOT INCLUDED ANY MORE - PLEASE ORDER IN ADDITION, PART NO 15-5971-007

SURFACE MOUNT VERSION WITH 3 PIN ASS3 CONNECTION



DESCRIPTION

with 1,5 m cable



PART NO
31-2307-017

FIXATION 90° BACK AND 3 PIN ASS3 CONNECTION



DESCRIPTION

with 1,5 m cable



PART NO
31-2367-037

24V LAMPS SIDE MARKER LAMPS

FIXATION 90° FRONT AND 3 PIN ASS3 CONNECTION



DESCRIPTION
with 1,5 m cable



PART NO
31-2367-057

SPARE PARTS / ACCESSORIES



DESCRIPTION
rubber pad
fixation 90° to the front
fixation 90° to the back
straight bracket
screw for angle (1 piece)
caps for P&R connector



PART NO
15-5111-007
15-5321-107
15-5321-207
15-5321-007
14-0418-307
15-5971-007

UNIPOINT I LED



SURFACE MOUNT VERSION PRE-ASSEMBLED WITH P&R CONNECTION

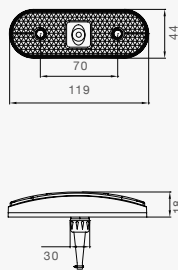

GENERAL DESCRIPTION

- With reflector.
- High light output with low current consumption.
- With ASS1/ASS2 connection on the backside of the lamp.

DESCRIPTION
with 0,5 m cable
with 1,5 m cable



PART NO
31-2004-017
31-2004-037

ATTENTION!!!

CAP FOR P&R CONNECTOR IS NOT INCLUDED ANY MORE - PLEASE ORDER IN ADDITION, PART NO 15-5971-007

FIXATION 90° BACK PRE-ASSEMBLED WITH P&R CONNECTION

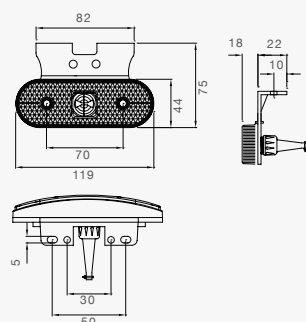

DESCRIPTION
with 0,5 m cable
with 1,5 m cable



PART NO
31-2064-017
31-2064-037

ATTENTION!!!

CAP FOR P&R CONNECTOR IS NOT INCLUDED ANY MORE - PLEASE ORDER IN ADDITION, PART NO 15-5971-007

FIXATION 90° FRONT PRE-ASSEMBLED WITH P&R CONNECTION

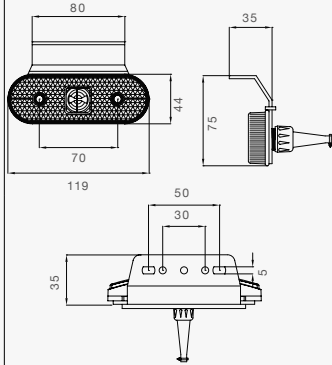

DESCRIPTION
with 0,5 m cable
with 1,5 m cable



PART NO
31-2064-717
31-2064-737

ATTENTION!!!

CAP FOR P&R CONNECTOR IS NOT INCLUDED ANY MORE - PLEASE ORDER IN ADDITION, PART NO 15-5971-007

FIXATION SLOPING ANGLE PRE-ASSEMBLED WITH P&R CONNECTION

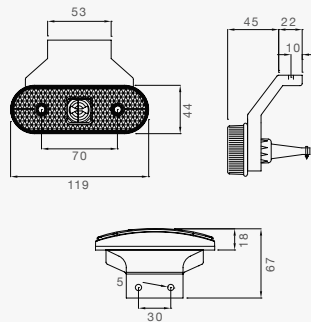

DESCRIPTION
with 0,5 m cable
with 1,5 m cable



PART NO
31-2064-217
31-2064-237

ATTENTION!!!

CAP FOR P&R CONNECTOR IS NOT INCLUDED ANY MORE - PLEASE ORDER IN ADDITION, PART NO 15-5971-007

FIXATION STRAIGHT PRE-ASSEMBLED WITH P&R CONNECTION

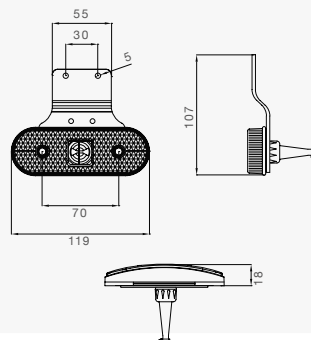

DESCRIPTION
with 0,5 m cable
with 1,5 m cable



PART NO
31-2064-417
31-2064-437

ATTENTION!!!

CAP FOR P&R CONNECTOR IS NOT INCLUDED ANY MORE - PLEASE ORDER IN ADDITION, PART NO 15-5971-007

SURFACE MOUNT VERSION WITH 3 PIN ASS3 CONNECTION



DESCRIPTION
with 0,5 m cable
with 1,5 m cable



PART NO
31-2007-237
31-2007-247

24V LAMPS SIDE MARKER LAMPS

FIXATION 90° BACK AND 3PIN ASS3 CONNECTION



DESCRIPTION

with 0,5 m cable
with 1,5 m cable



PART NO

31-2067-097
31-2067-107

FIXATION 90° FRONT AND 3PIN ASS3 CONNECTION



DESCRIPTION

with 1,5 m cable



PART NO

31-2067-697

UNIPOINT I VERTICAL WITH REFLECTOR AND P&R CONNECTION



DESCRIPTION

vertical version with
1,5 m cable



PART NO

31-2004-107

ATTENTION!!!

CAP FOR P&R CONNECTOR IS NOT INCLUDED ANY MORE - PLEASE ORDER IN ADDITION, PART NO 15-5971-007

SPARE PARTS / ACCESSORIES



DESCRIPTION

lens loose
lens loose incl. fixation 90° to the back
lens loose incl. sloping angle to the back
connection loose single grommet
connection loose double grommet
front cable supply for Unipoint with 0,25 m P&R
fixation 90° back
straight bracket
sloping angle to the back
sloping angle to the front
expanding rivet for lamp 14-15mm
cap for P&R connector



PART NO

21-2000-004
21-2000-014
21-2000-024
15-5624-014
15-5624-024
68-5018-007
15-5319-007
15-5317-007
15-5317-017
15-5319-307
14-4596-007
15-5971-007



UNIPOINT MAXX LED MAXIMUM INTENSITY LED SIDEMARKER

SURFACE MOUNT VERSION WITH P&R CONNECTION

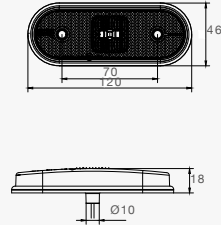

GENERAL DESCRIPTION

- Sidemarker light with maximum legal light intensity output power.
- Compatible with Aspöck SMCG.
- Robust design.
- High luminous efficiency at low power consumption.
- Suitable to use on the Aspöck Unipoint bracket range.
- For horizontal use.

DESCRIPTION

with 2,0 m cable



PART NO
31-2104-067



UNIPOINT DI + SML LED SIDEMARKER LAMP WITH DIRECTION INDICATOR

SURFACE MOUNT VERSION WITH 3 PIN ASS3 CONNECTION

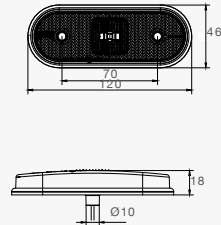

GENERAL DESCRIPTION

- Two in one: side marker lamp with direction indicator.
- Same design as Unipoint I.
- Robust design.
- Compatible with the bracket of Aspöck Unipoint.
- Easy integration into the Aspöck cabling.
- Equipped with polarity reversal protection.
- Available in different variants.

DESCRIPTION

with 1,5 m cable



PART NO
31-2107-017



UNIPOINT DI LED DIRECTION INDICATOR FOR MOUNTING ON THE SIDE

SURFACE MOUNT VERSION WITH P&R CONNECTION

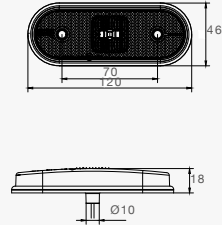

GENERAL DESCRIPTION

- LED direction indicator in side marker design (Unipoint I).
- Robust design.
- Compatible with the bracket of Aspöck Unipoint.
- Easy integration into the Aspöck cabling.
- Equipped with polarity reversal protection.
- Available in different variants.

DESCRIPTION

with 1,5 m cable



PART NO
31-2104-077

SURFACE MOUNT VERSION WITH 2 PIN ASS3



DESCRIPTION

with 1,5 m cable



PART NO
31-2107-007

24V LAMPS END OUTLINE MARKER LAMPS

SUPERPOINT IV LED



VERSION STANDARD WITH P&R CONNECTION

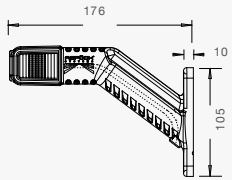

GENERAL DESCRIPTION

- End outline marker in clear glass design complete in LED.
- Flexible fitting arms (rubber).
- Lamp includes side marker lamp.

DESCRIPTION

red/white/orange left, with 2 m cable
red/white/orange right, with 2 m cable



PART NO
31-3104-007
31-3104-017

ATTENTION!!!

CAP FOR P&R CONNECTOR IS NOT INCLUDED ANY MORE - PLEASE ORDER IN ADDITION, PART NO 15-5971-007

VERSION STANDARD WITH ASS2 CONNECTION



DESCRIPTION

red/white/orange left, with 2 m cable
red/white/orange right, with 2 m cable

red/withe/orange left with 0.5 m cable
red/white/orange right with 0.5 m cable



PART NO
31-3105-007
31-3106-007

31-3105-017
31-3106-017

VERSION DIRECT MOUNTING

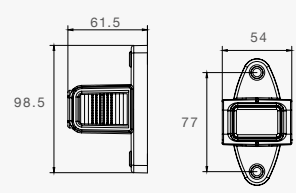

DESCRIPTION

red/white/orange left, with P&R connection, with 2 m cable
red/white/orange right, with P&R connection, with 2 m cable



PART NO
31-3104-067
31-3104-077

24V LAMPS END OUTLINE MARKER LAMPS

VERSION PENDULAR BRACKET

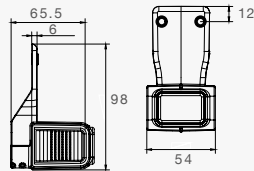

DESCRIPTION

red/white/orange left, with P&R connection, with 2 m cable

red/white/orange right, with P&R connection, with 2 m cable



PART NO

31-3104-087

31-3104-097

VERSION SHORT

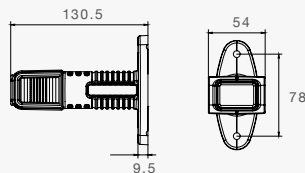

DESCRIPTION

red/white/orange left, with P&R connection, with 2 m cable

red/white/orange right, with P&R connection, with 2 m cable



PART NO

31-3104-047

31-3104-057

FLEXIPOINT LED

FLEXIPOINT LED RED/WHITE, WITH P&R CONNECTION



DESCRIPTION

1 m cable open end

1 m cable



PART NO

31-6300-007

31-6304-017

ATTENTION!!!

CAP FOR P&R CONNECTOR IS NOT INCLUDED ANY MORE - PLEASE ORDER IN ADDITION, PART NO 15-5971-007

WITH HANGER AND P&R CONNECTION



DESCRIPTION

1 m cable left

1 m cable right



PART NO

31-6364-007

31-6364-017



SUPERPOINT III LED

STANDARD VERSION WITH P&R CONNECTION

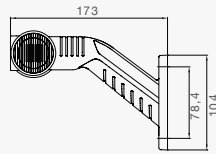

GENERAL DESCRIPTION

- End outline marker in clear glass design complete in LED.
- Flexible fitting arms (rubber) in different designs.
- Lamp includes side marker lamp.

DESCRIPTION

- red/white/orange left, with 1,25 m cable
- red/white/orange right, with 1,25 m cable
- black/white/orange left, with 1,25 m cable
- black/white/orange right, with 1,25 m cable



PART NO

- 31-3304-047
- 31-3304-057
- 31-3304-067
- 31-3304-077

ATTENTION!!!

CAP FOR P&R CONNECTOR IS NOT INCLUDED ANY MORE - PLEASE ORDER IN ADDITION, PART NO 15-5971-007

STANDARD VERSION WITH ASS2 CONNECTION



DESCRIPTION

- red/white/orange left, with 1,75 m cable
- red/white/orange right, with 1,75 m cable
- black/white/orange left, with 1,75 m cable
- black/white/orange right, with 1,75 m cable



PART NO

- 31-3305-017
- 31-3306-017
- 31-3305-027
- 31-3306-027

STANDARD VERSION, OPEN END



DESCRIPTION

- red/white/orange left, with 4 m cable
- red/white/orange right, with 4 m cable
- black/white/orange left, with 4 m cable
- black/white/orange right, with 4 m cable



PART NO

- 31-3303-007
- 31-3302-007
- 31-3303-017
- 31-3302-017

24V LAMPS END OUTLINE MARKER LAMPS

VERSION DIRECT MOUNTING WITH P&R CONNECTION

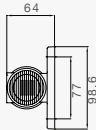

DESCRIPTION

red/white/orange left/right 1,5 m cable
black/white/orange left/right 1,5 m cable



PART NO
31-3364-007
31-3364-017

ATTENTION!!!

CAP FOR P&R CONNECTOR IS NOT INCLUDED ANY MORE - PLEASE ORDER IN ADDITION, PART NO 15-5971-007

VERSION DIRECT MOUNTING, OPEN END



DESCRIPTION

red/white/orange left/right 4 m cable
black/white/orange left/right 4 m cable



PART NO
31-3360-007
31-3360-017

VERSION WITH PENDULAR BRACKET, P&R CONNECTION

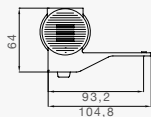

DESCRIPTION

red/white/orange left 1,5 m cable
red/white/orange right 1,5 m cable
black/white/orange left 1,5 m cable
black/white/orange right 1,5 m cable



PART NO
31-3364-057
31-3364-027
31-3364-047
31-3364-037

ATTENTION!!!

CAP FOR P&R CONNECTOR IS NOT INCLUDED ANY MORE - PLEASE ORDER IN ADDITION, PART NO 15-5971-007

VERSION WITH PENDULAR BRACKET, OPEN END



DESCRIPTION

red/white/orange left 4 m cable
red/white/orange right 4 m cable
black/white/orange left 4 m cable
black/white/orange right 4 m cable



PART NO
31-3365-017
31-3366-027
31-3365-027
31-3366-017

STRAIGHT VERSION WITH P&R CONNECTION

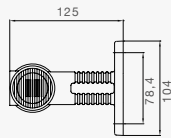

DESCRIPTION

red/white/orange right/left
P&R 1,25 m cable
black/white/orange right/left
P&R 1,25 m cable



PART NO
31-3304-097
31-3304-087

ATTENTION!!!

CAP FOR P&R CONNECTOR IS NOT INCLUDED ANY MORE - PLEASE ORDER IN ADDITION, PART NO 15-5971-007

STRAIGHT VERSION WITH ASS2 CONNECTION



DESCRIPTION

red/white/orange right/left
1,75 m cable
black/white/orange right/left
1,75 m cable



PART NO
31-3307-017
31-3307-007

STRAIGHT VERSION, OPEN END



DESCRIPTION

red/white/orange right/left
4 m cable
black/white/orange right/left
4 m cable



PART NO
31-3300-247
31-3300-317

STANDARD VERSION WITH 3 PIN ASS3

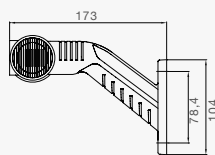

DESCRIPTION

red/white/orange right, with
1,25 m cable
black/white/orange right, with
1,25 m cable
red/white/orange left, with
1,25 m cable
black/white/orange left, with
1,25 m cable



PART NO
31-3306-127
31-3306-167
31-3305-127
31-3305-167

SPARE PARTS / ACCESSORIES



DESCRIPTION

Superpoint III LED Lens red/
white/orange 4 m open end
Superpoint III LED Lens black/
white/orange 4 m open end
Superpoint III rubber arm lose
(standard version)
Superpoint III rubber arm lose
(straight version)
Superpoint III rubber arm lose
(direct mounting)
Superpoint III rubber arm lose
(pendant bracket)
cap for P&R connector



PART NO
21-3351-707
21-3350-707
21-3300-007
21-3302-007
15-5325-007
15-5325-107
15-5971-007



24V LAMPS NUMBER PLATE LAMPS

REGPOINT II LED NUMBER PLATE LIGHT LED



STANDARD

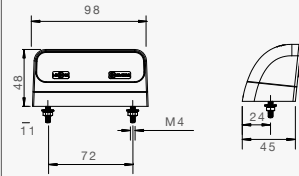

DESCRIPTION

- P&R, 0,5 m
- P&R, 2,0 m
- ASS2, 0,5 m
- ASS2, 2,0 m
- ASS3, 0,5 m



PART NO

- 36-3804-007
- 36-3804-017
- 36-3806-007
- 36-3805-007
- 36-3810-007

FOR SINGLE MOUNTING

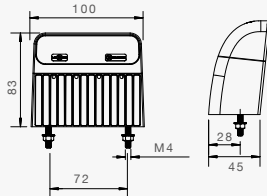

DESCRIPTION

- P&R, 0,5 m
- P&R, 2,0 m
- ASS2, 0,5 m
- ASS2, 2,0 m
- ASS3, 0,5 m



PART NO

- 36-3864-007
- 36-3864-017
- 36-3867-017
- 36-3867-027
- 36-3865-007

REGPOINT LED



WITH P&R CONNECTION

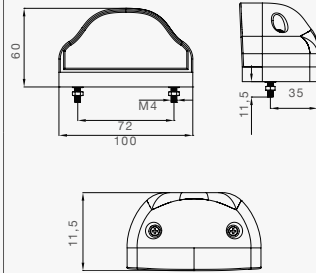

GENERAL DESCRIPTION

- LED number plate light.
- Same dimensions like the bulb version.
- High light yield with 2 LEDs.
- Cable and lightning devices are shed.

DESCRIPTION

- with 0,5 m cable
- with 1,0 m cable
- with 3,5 m cable



PART NO

- 36-3604-007
- 36-3604-017
- 36-3604-027

ATTENTION!!!

CAP FOR P&R CONNECTOR IS NOT INCLUDED ANY MORE - PLEASE ORDER IN ADDITION, PART NO 15-5971-007

WITH 2 PIN ASS2 CONNECTOR



DESCRIPTION

- with 0,5 m cable
- with 1,0 m cable
- with 3,5 m cable



PART NO

- 36-3607-007
- 36-3607-017
- 36-3607-027

SPARE PARTS / ACCESSORIES



DESCRIPTION

- cap for P&R connector



PART NO

- 15-5971-007



REGPOINT

WITH P&R CONNECTION

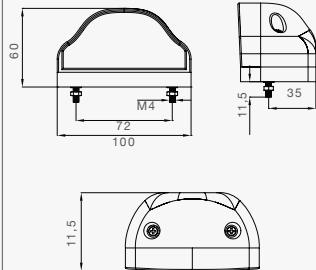

GENERAL DESCRIPTION

- Number plate light with modern design.
- Festoon bulb 5W - shock proof.
- Cable glands as cable entry on the bottom of the lamp.
- Various mounting options.

DESCRIPTION

- with 0,5 m cable
- with 1,0 m cable
- with 3,5 m cable



PART NO

- 36-3004-017
- 36-3004-027
- 36-3004-057

ATTENTION!!!

CAP FOR P&R CONNECTOR IS NOT INCLUDED ANY MORE - PLEASE ORDER IN ADDITION, PART NO 15-5971-007

WITH ASS2 CONNECTION



DESCRIPTION

- with 0,5 m cable
- with 1,0 m cable
- with 2,5 m cable



PART NO

- 36-3007-007
- 36-3007-057
- 36-3007-047

WITH 3 PIN. ASS3 CONNECTION



DESCRIPTION

- with 0,5 m cable



PART NO

- 36-3007-397

SPARE PARTS / ACCESSORIES



DESCRIPTION

- complete lamp with cable glands in plastic bag
- festoon bulb 24V 5W
- cup for P&R connector



PART NO

- 26-3000-004
- 16-6705-007
- 15-5971-007

24V LAMPS NUMBER PLATE LAMPS



REGPOINT RED

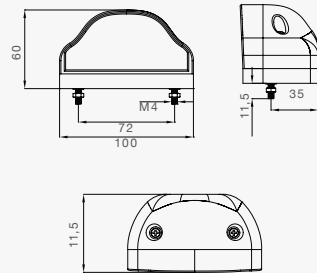

GENERAL DESCRIPTION

- Number plate light with modern design.
- Festoon bulb 5W - shock proof.
- Cable glands as cable entry on the bottom of the lamp.
- Red lens - ATTENTION: note legal regulations.
- Various mounting options.

DESCRIPTION

lamp red complete with cable glands



PART NO

26-3010-004

SPARE PARTS / ACCESSORIES



DESCRIPTION

transparent red lens

Festoon bulb 24V 5W



PART NO

18-8630-104

16-6705-007

24V LAMPS NUMBER PLATE LAMPS

NUMBER PLATE HOLDER LED

VERSION WITH P&R CONNECTION WITHOUT 3RD STOP LIGHT

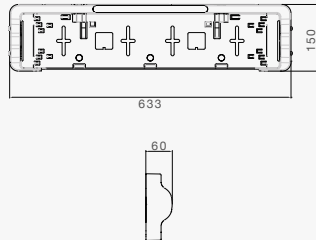

GENERAL DESCRIPTION

- Fitting for each european number plates (except UK).
- Integrated LED lighting on both sides.
- Simple mounting.
- Dimensions (633 x 150 x 60 mm).
- Only 1 connection for both lamps.

DESCRIPTION

- with 0,5 m P&R
- with 1,0 m P&R
- with 3,5 m P&R



PART NO
36-3764-007
36-3764-017
36-3764-027

ATTENTION!!!

CAP FOR P&R CONNECTOR IS NOT INCLUDED ANY MORE - PLEASE ORDER IN ADDITION, PART NO 15-5971-007

VERSION WITH ASS2 CONNECTION WITHOUT 3RD STOP LIGHT



DESCRIPTION

- with 0,5 m flat cable
- with 1,0 m flat cable
- with 3,5 m flat cable



PART NO
36-3767-007
36-3767-017
36-3767-027

VERSION OPEN END WITH 3RD STOP LIGHT



DESCRIPTION

- with 3,5 m cable and 3rd stop light
- 2,0 m cable open end



PART NO
36-3760-017

SPARE PARTS / ACCESSORIES



DESCRIPTION

- 3rd stop light 2,0 m cable open end



PART NO
31-8900-027

NUMBER PLATE PAD

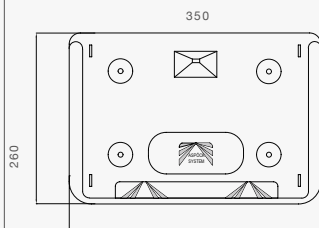
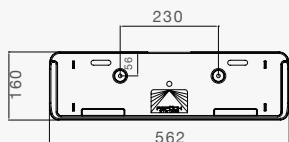

GENERAL DESCRIPTION

- Fixation of the number plate with flexible rubber holder.
- For single-line and double-line number plates.

DESCRIPTION

number plate pad
520 x 120 x 28 mm

number plate pad „Version
UK“, 345 x 256 x 28 mm

number plate pad, 345 x 256
x 28 mm including number
plate light with 1 m P&R



PART NO
15-5392-017

15-5398-507

87-1272-004

SPARE PARTS / ACCESSORIES

DESCRIPTION

bracket for Regpoint Lamp
3rd stop light 2 m open end



PART NO
15-5398-067
31-8900-027

3RD STOP LIGHT



built in version

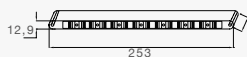

version incl. housing

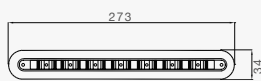

surface mounting version

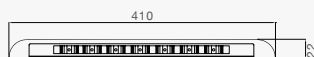

GENERAL DESCRIPTION

- various mounting possibilities
- increasing safety in traffic
- compact dimensions

DESCRIPTION

built in version with 0,5 m open
end

built in version with 2,0 m ASS1
connection

including housing with 0,5 m
open end

including surface-case with
2,0 m open end



PART NO
31-8900-017

31-8907-007

31-8910-017

31-9000-057

64 lux 32 lux 16 lux 8 lux 4 lux 2 lux 1,5 lux

WORKING LAMP LED

WORKPOINT LED 650

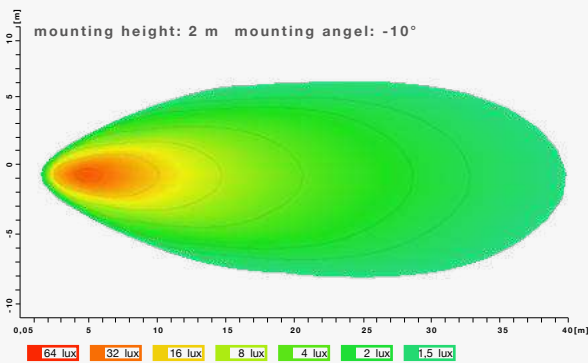
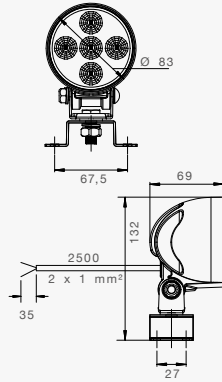

GENERAL DESCRIPTION

- long life expectancy
- very low current consumption
- water and steam resistant
- standard mounting
- all purpose (near field lighting and spot lighting)
- overheating protection
- ~650 lumen

DESCRIPTION

2,5 m open end
2,5 m ASS2



PART NO

39-6400-017
39-6407-007

WORKPOINT LED 800

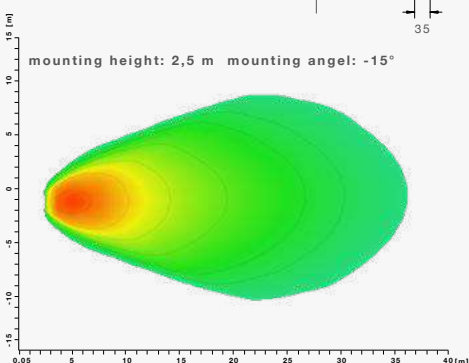
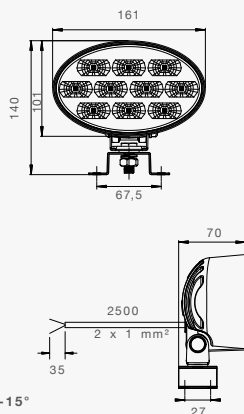

GENERAL DESCRIPTION

- long life expectancy
- very low current consumption
- water and steam resistant
- standard mounting
- all purpose (near field lighting and spot lighting)
- overheating protection
- ~800 lumen

DESCRIPTION

2,5 m open end
2,5 m ASS2



PART NO

39-6800-017
39-6807-007

WORKING LAMP LED

WORKPOINT LED 3000

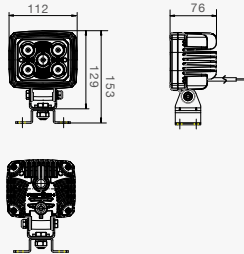

GENERAL DESCRIPTION

- long life expectancy
- high light output
- very low current consumption
- temperatur range of -40 °C ~ 80 °C
- steam and water resistant
- standard mounting
- die-cast aluminium for maximum heat dissipation
- ~3000 lumen

DESCRIPTION

1.5 m open end cable,
spot beam (20°)

1.5 m open end cable, flood
beam (60°)



PART NO

38-8221-007

38-8221-107



WORKING LAMP LED / REVERSE LAMP LED

WORKPOINT LED 1500

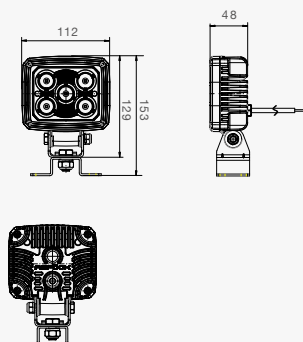

GENERAL DESCRIPTION

- admitted to the reversing light
- long life expectancy
- high light output
- very low current consumption
- temperatur range of -40 °C ~ 80 °C
- steam and water resistant
- standard mounting
- die-cast aluminium for maximum heat dissipation
- ~1500 lumen

DESCRIPTION

1.5 m open end cable



PART NO

38-8220-007



WORKING LIGHT - REVERSING LIGHT



21 W

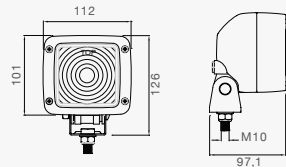

GENERAL DESCRIPTION

- According to the new guidelines it is able to be mounted as working light as well as reversing light.
- Large high light output in spite of compact dimensions
- Swinging socket.
- In 21W version and 70W version available.

DESCRIPTION

- 21W with 1,5 m ASS2
- 21W with 2,5 m ASS2
- 21W with 2,5 m open end



PART NO

- 38-9007-007
- 38-9007-017
- 38-9000-007

70 W

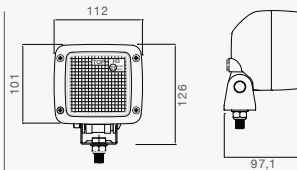

DESCRIPTION

- 70W H3 with 1,5 m ASS2
- 70W H3 with 2,5 m ASS2
- 70W H3 with 2,5 m open end



PART NO

- 38-9107-007
- 38-9107-017
- 38-9100-007

SPARE PARTS AND ACCESSORIES

DESCRIPTION

- reverse 70 W - as spare part incl. 24V 70W H3 lamp



PART NO

- 28-9100-007

REVERSING LAMP LED OVAL

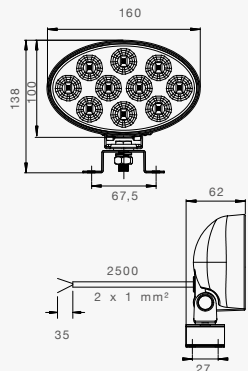

10 grad Neigungswinkel
10 degree tilt angle

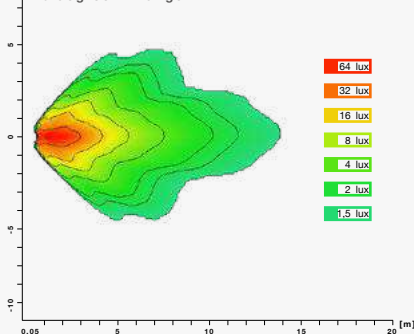

GENERAL DESCRIPTION

- very low current consumption
- temperature range from -40°C to +80°C
- water and steam resistant
- maintenance free and long life expectancy (approx. 20,000 hours) due to LED technology
- dual voltage 12V / 24V
- high gloss reflector
- light emission 150 x 82 mm
- permitted according to ECE48/ADR
- 200 lumen

DESCRIPTION

- 2,5 m open end
- 2,5 m with 2 pin ASS2



PART NO

- 38-8200-007
- 38-8207-007

24V LAMPS INTERIOR LAMP

INPOINT III LED

LED INTERIOR LAMP

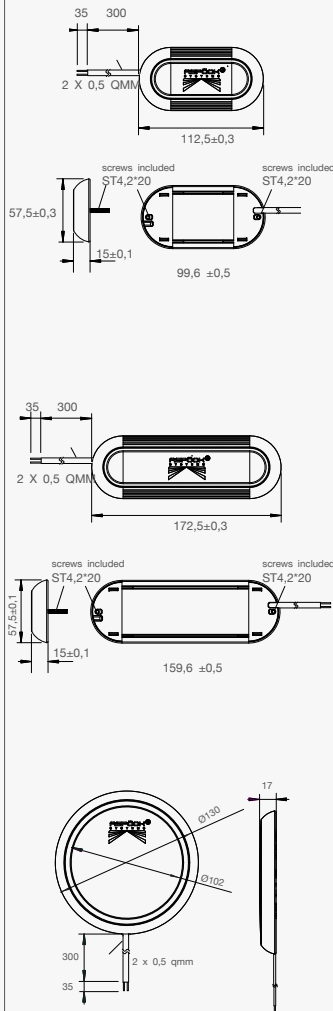

GENERAL DESCRIPTION

- long life expectancy
- high light output
- very low current consumption
- lens in frosted optic
- standard mounting
- dual voltage
- optional with switch, or motion sensor (PIR Sensor)

DESCRIPTION

interior lamp LED short, 0.3 m cable open end

interior lamp LED short, with switch, 0.3 m cable open end

interior lamp LED short, with motion sensor, 0.3 m cable open end

interior lamp LED long, 0.3 m cable open end

interior lamp LED long, with switch, 0.3 m cable open end

interior lamp LED long, with motion sensor, 0.3 m cable open end

interior lamp LED round, 0.3 m cable open end

interior lamp LED round, with switch, 0.3 m cable open end

interior lamp LED round, with motion sensor, 0.3 m cable open end

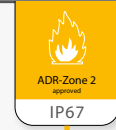

- with motion sensor

- without switch
- with switch



PART NO

39-8900-157

39-8900-257

39-8900-207

39-8900-007

39-8900-107

39-8900-057

39-8900-307

39-8900-407

39-8900-357

LED-INTERIOR LAMP

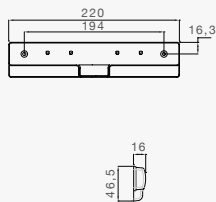

GENERAL DESCRIPTION

- high-power LEDs for a high output
- compact dimensions
- easy mounting
- universal using

DESCRIPTION

- with 0,25 m P&R
- with 1,50 m P&R
- with 1,50 m open end



PART NO

- 39-8704-007
- 39-8704-017
- 39-8700-017

ATTENTION!!!

CAP FOR P&R CONNECTOR IS NOT INCLUDED ANY MORE - PLEASE ORDER IN ADDITION, PART NO 15-5971-007

INTERIOR LAMP LED ROUND

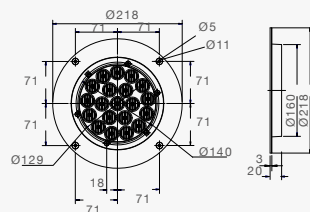

GENERAL DESCRIPTION

* ADR Zone 2 - only with additional isolated tube

- very low current consumption
- high grade LED, 20 pieces
- maintenance free and long life expectancy
- splash proof
- dual voltage 12V / 24V
- 480 lm

DESCRIPTION

interior lamp LED round open end, including plate



PART NO

29-8410-107

24V Standard Wiring Systems





24V STANDARD WIRING SYSTEMS

FRONT CONNECTION

FRONT CONNECTION WITH 17 PIN ASS3 CONNECTOR

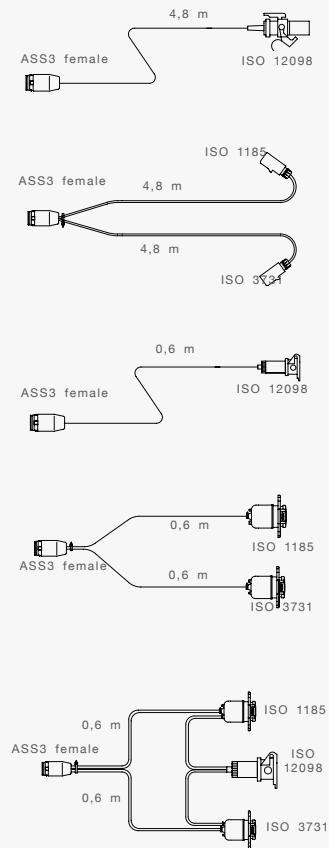

DESCRIPTION

4,8 m and 15 pin plug, version ADR

4,8 m and N+S plug

0,6 m cable and 15 pin socket, version ADR

0,6 m and N+S socket

N+S and 15 pin socket



PART NO
53-1667-037

58-6024-017

53-6768-007

58-6649-007

58-6647-007

MAIN CABLES

MAIN CABLE WITH 17 PIN ASS3 CONNECTION, VERSION ADR

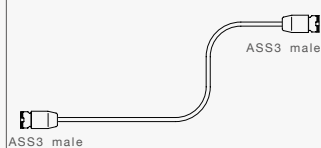

DESCRIPTION

9 m 6 x 1 + 2 x 2,5 mm²
 12,5 m 6 x 1 + 2 x 2,5 mm²
 15 m 6 x 1 + 2 x 2,5 mm²
 9 m 7 x 1 + 1 x 1,5 + 2 x 2,5 mm²
 12,5 m 7 x 1 + 1 x 1,5 + 2 x 2,5 mm²
 15 m 7 x 1 + 1 x 1,5 + 2 x 2,5 mm²
 9,0 m 12 x 1 + 3 x 2,5 mm²
 12,5 m 12 x 1 + 3 x 2,5 mm²
 15 m 12 x 1 + 3 x 2,5 mm²



PART NO
 65-1003-007
 65-1003-017
 65-1003-027
 65-1005-007
 65-1005-017
 65-1005-027
 65-1007-007
 65-1007-017
 65-1007-027

SML-LOOM / FLAT CABLE

FLATCABLE, 2 x 1,5MM², FOR P&R CONENCTION, VERSION ADR



DESCRIPTION

- 13 m cable, ASS1
- 15 m cable, ASS1
- 16 m cable, ASS1
- 17 m cable, ASS1



PART NO
68-7503-007
68-7503-017
68-7503-177
68-7503-027

SML-LOOM WITH 3 PIN ASS3 CONNECTIONS, VERSION ADR

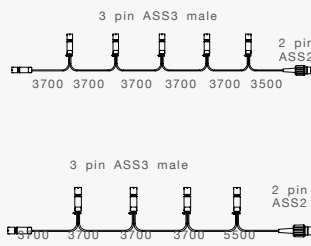

DESCRIPTION

- with 6 x ASS3 3 pin. + 1 x ASS2
- with 5 x ASS3 3 pin. + 1 x ASS2



PART NO
87-1285-007
87-1284-007

REAR SUPPLY CABLE

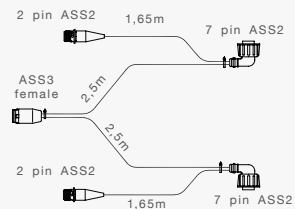

DESCRIPTION

ADR version



PART NO
68-4983-007

24V STANDARD WIRING SYSTEMS

ADAPTER CABLES

ADAPTER CABLE WITH 17 PIN ASS3 CONNECTION, VERSION ADR

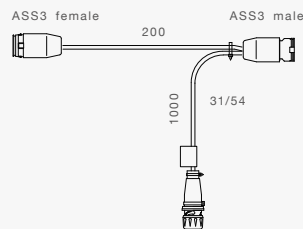

DESCRIPTION

8 core cable with single connection for brake



PART NO

66-8892-007

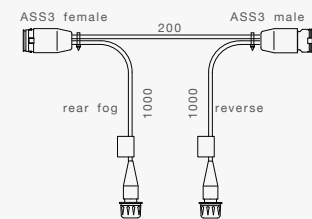

9 core cable with double connection for reverse and rear fog

66-8893-007

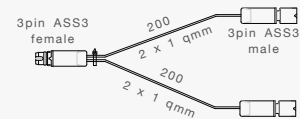

Y-cable 3pin ASS3

65-6499-007

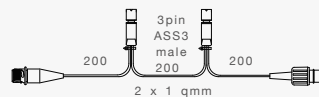

extension for SML chain
eg: 87-1288-007

87-1286-007

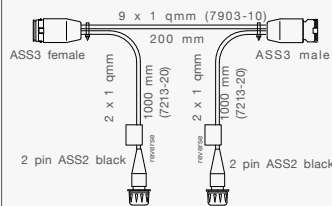

9 core cable with double connection for reverse

65-6101-027

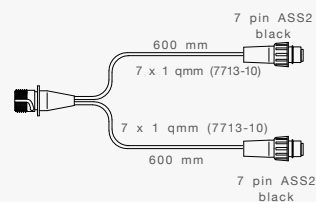

adapter for double lighting

68-4980-037

EXTENSION CABLE

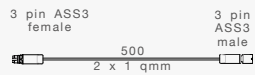

DESCRIPTION

extension cable 3 pin ASS3
0,5 m



PART NO

65-1499-007

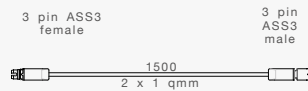

extension cable 3 pin ASS3
1,5 m

65-1499-017

24V Junction Boxes





24V JUNCTION BOXES SOCKET JUNCTION BOX

SOCKET JUNCTION BOX

3-SOCKET JUNCTION BOX

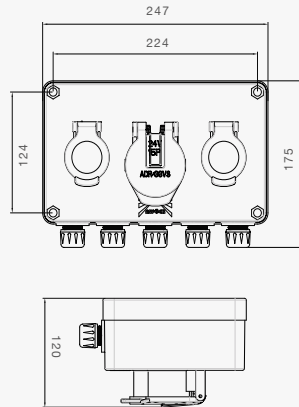

GENERAL DESCRIPTION

- Pre-assembled multifunction housing
 - 1) socket ISO 1185
 - 2) socket ISO 3731
 - 3) socket ISO 12098
- Interchangeable housings in bayonet version ISO 1185, 3731, and 12098.
- 5 pins (cable glands or 2 pin ASS2 connection)
- Not ADR tested.

DESCRIPTION

0,6 m 17 pin ASS3 connector
0,6 m 15 pin bayonet connector



PART NO

76-7037-007
76-7002-007

Important notice regarding the 3-socket junction box:

Caution: ADR vehicles (Carriage of Dangerous Goods) may only use the 15 pin connector (ISO 12098)! Do not use the other available sockets! There is danger of fire and explosion and danger to life!

This would be the way to make the 3-socket junction box suitable for an ADR Zone 2 usage:

To use the 3-socket junction box for ADR, please fit the safety caps into the ISO 1185 and ISO 3731 sockets.



2 pc. safety caps for ISO 1185 and ISO 3731 sockets

15-5280-154

1-SOCKET JUNCTION BOX

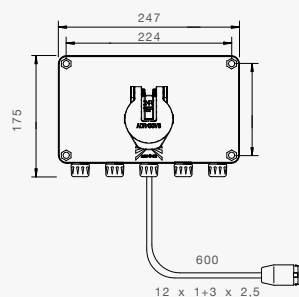

GENERAL DESCRIPTION

- pre-assembled multifunction housing ISO 12098
- Interchangeable housings in bayonet version ISO 12098
- 5 pins (cable glands or 2 pin ASS2 connection)

DESCRIPTION

0,6 m 17 pin ASS3 connector



PART NO

76-7072-007

SPARE PARTS / ACCESSORIES



DESCRIPTION

2 pc. safety caps for ISO 1185 and ISO 3731 sockets

pre-wired spare parts for self-assembly

complete wired cable set with connector strip and inserts

insert IOS12098 (15 pin)

insert ISO1185 (7 pin)

insert ISO3731 (7 pin)



PART NO

15-5280-154

76-7001-007

58-3008-007

69-0001-004

69-0002-004

69-0003-004

JUNCTION BOX ASS1

JUNCTION BOX ASS1

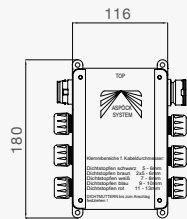
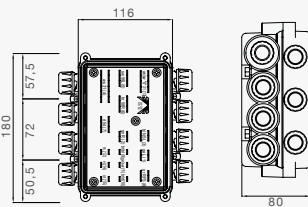
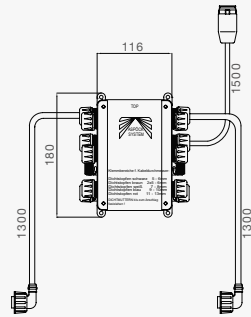

GENERAL DESCRIPTION

- Easy and time-saving mounting of the junction box by pre-wiring.
- Not necessary to open the box - absolutely waterproof IP54.
- Colored coding outside determines function.
- All cables in colors and numbers according to ISO 12098 (15 pins).
- All flat plugs in the box are 6,3 mm spades.
- The unused entries on the cover are spare entries for the trailer user.

DESCRIPTION

with rear lamp connection
ADR



PART NO
76-6430-007

with ASS3 direct connector

76-5123-007

SPARE PARTS / ACCESSORIES



DESCRIPTION

- junction box loose
with high cover
- junction box loose
with low cover



PART NO
76-5100-007

76-5100-047

24V Rear Bumper





24V REAR BUMPER

ASPÖCK ALUMINIUM REAR BUMPER

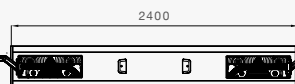
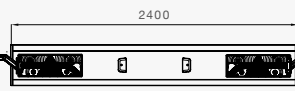
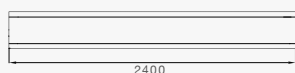
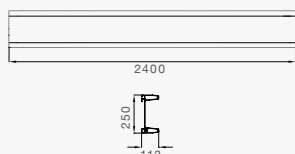

GENERAL DESCRIPTION

- Types: 2,4 m anodized or white, pre-drilled for all necessary Aspöck lights and junction boxes:
- Net weight without wiring or surface mounting parts about 17 kg.
- "E" approved.

DESCRIPTION

loose anodised, only drilled including protection caps

anodised with: Europoint II, Superpoint II and rear supply cable

anodised with: Europoint II (with 1 x tail light in LED), Superpoint II and junction box

anodised with: Europoint II, Superpoint III LED, number plate light (LED version) and junction box

anodised with: Europoint III standard, Superpoint IV LED, number plate light (bulb version), and junction box

anodised with: Europoint III LED, Superpoint IV & LCG for direction indicator incl. number plate light (LED), and junction box



PART NO

14-4164-001



97-1267-007



97-1269-007

97-1270-007

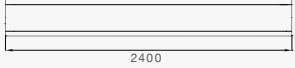
97-1257-007

97-1279-007

		<p>DESCRIPTION</p> <p>loose white, only drilled including protection caps</p>		<p>PART NO</p> <p>14-4164-021</p>
---	---	--	---	---

<p>SPARE PARTS</p> 		<p>DESCRIPTION</p> <p>protection caps for aluminium rear bumper (2 pieces)</p>		<p>PART NO</p> <p>15-5394-014</p>
--	--	---	---	---

24V Electronics Accessories





24V ELECTRONIC ACCESSORIES

GENERAL ADVICE!

Led lighting draws less current than incandescent lamps.

This is known to cause problems with certain vehicle bulb failure monitoring systems, across all manufacturers.

The low power consumption of led lamps can lead to a visual error message to the driver.

As monitoring of the direction indicator is a mandatory requirement, we recommend Aspöck LED lamps are always used in conjunction with our Led Control Gear „LCG“. Aspöck cannot accept any liability for incompatibility of the „LCG“ with the non-mandatory functions, these are provided for driver convenience. With the variation of vehicle types available it is impossible for Aspöck to verify every combination.

It is the driver of the vehicles legal responsibility to check whether all lighting is operating correctly.

It must also be noted that the maximum current for each function is 3A. Please take care if connecting a vehicle to an „AC source or pulsed DC“ as this will lead to component failure.

No liability will be accepted for the use of „LCG“ with non-approved vehicles or lamps.

Aspöck accepts no other terms and installation of our products will be deemed as full acceptance of our terms and conditions.

* LCG 1 - V2 LED-CONTROL-GEAR

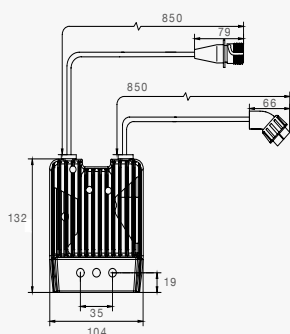

GENERAL DESCRIPTION

- This LED control gear adapts the electrical characteristics of LED lights, to fit on trucks, which are not compatible with LEDs until now.
- Compact construction.
- A simple and quick retrofitting in a consisting Aspöck lighting system by the fitting plugs is possible.
- Dimulation of a bulb on the following functions: direction indicator, tail light, brake light.
- Gault detection of the LED direction indicator function.
- **Important: For every LED rear lamp, one LCG is needed (i.e. per vehicle 2 pieces of LCG1).**
- **Attention: The LCG is only compatible with Aspöck LED rear lamps.**

DESCRIPTION

with 7 pin ASS1 and ASS2 connection for Aspöck rear lamps



PART NO

75-0300-107

* please notice the general advice

* LCG 2 - CENTRAL LCG

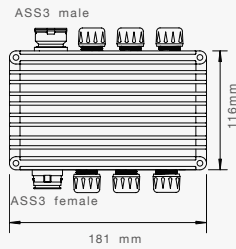

GENERAL DESCRIPTION

- This LED control gear adapts the electrical characteristics of LED lights, to fit on trucks, which are not compatible with LEDs until now.
- Compact building method (installed at the ASS1 junction box)
- A simple and rapid retrofit into an existing Aspöck lighting system is possible, by the suitable ASS3 plugs.
- Controls only the direction indicator functions (power- and failure -control).
- Current adaptation on the following functions: tail light, brake light, reversing light fog light.
- Cer lightning set is only one LCG 2 needed.
- **Attention: the LCG is only compatible with Aspöck LED rear lamps.**

DESCRIPTION

LCG 2 - standard version
LCG 2 - without direction indicator control



PART NO

75-0310-007

75-0309-007

* LCG 3

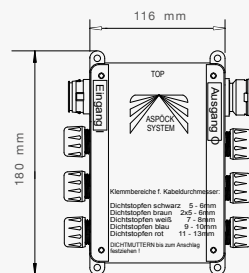

GENERAL DESCRIPTION

- This LED control gear adapts the electrical characteristics of LED lights, to fit on trucks, which are not compatible with LEDs until now.
- PERMANENT POWER REQUIRED
 - patented functioning system
 - indicator monitoring ensured
 - no failure messages with onboard computers
 - completely waterproof light system incl. rear lamp possible.
- The LED control gear enables the connection of LED rear lamps to tractor units, even if they are equipped with electronic lamp failure detection systems and onboard computers. Additionally, all light functions are monitored so that any malfunctions that may arise are displayed on the onboard computer.
- **Attention: the LCG is only compatible with Aspöck LED rear lamps**

DESCRIPTION

LCG 3



PART NO

76-5132-017

RDC premium



RDC - PREMIUM

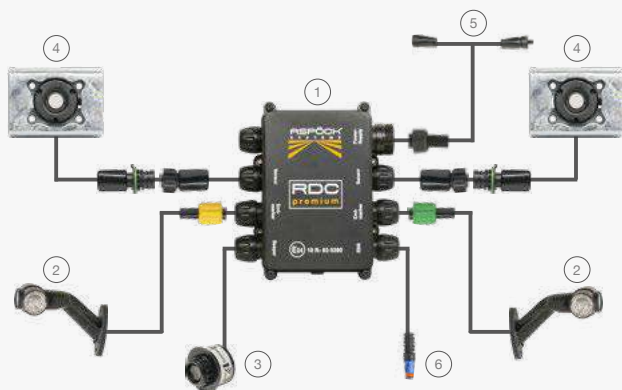

GENERAL DESCRIPTION

- Ramp-distance-control with activation of EBS-modules from various manufacturers.
- This ramp-distance-control is a system by Aspöck to ease the driving to the ramp with trailers, avoiding damages on the vehicle.
- More security for objects and persons behind the vehicle.
- Secure driving on the loading ramp.
- Adjustable ultrasonic sensors.
- Optical (by end outline marker) and acoustic (by the reversing beeper) warning signal.
- Easy installation on the vehicle and easy conversion.
- By engaging the reverse gear twice, the warning signal becomes „night silent“.

RDC - PREMIUM KIT

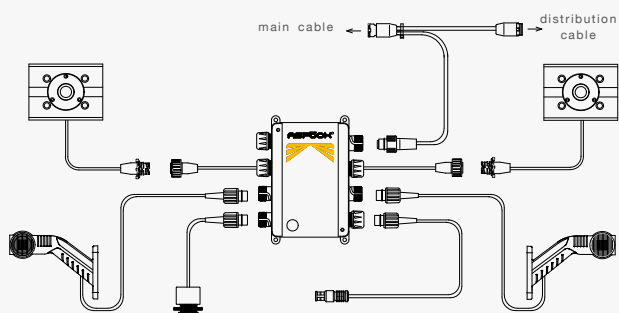

DESCRIPTION

- RDC-Premium Haldex including metal buffer
- RDC-Premium Haldex without metal buffer
- RDC-Premium Knorr TEBS G2.1 P. including metal buffer
- RDC-Premium Knorr TEBS G2.1 P. without metal buffer
- RDC-Premium Knorr TEBS G2.2 P. including metal buffer
- RDC-Premium Knorr TEBS G2.2 P. without metal buffer



PART NO

- 99-3010-251
- 99-3010-241
- 99-3010-201
- 99-3010-221
- 99-3010-291
- 99-3010-281

COMPONENTS & ACCESSORIES



DESCRIPTION

- ④ RDC Sensor including metal buffer
- RDC Sensor without metal buffer
- ② End outline marker Superpoint III LED right, with 2,1 m cable
- ② End outline marker Superpoint III LED left, with 2,1 m cable
- ③ reversing beeper
- ① RDC-distribution box Haldex
- RDC-distribution box Knorr
- ⑤ connector cable 3 m
- ⑤ connector cable 8 m
- RDC sticker 100 pc
- screwdriver



PART NO

- 75-0201-617
- 75-0204-117
- 31-3306-047
- 31-3305-047
- 75-0001-007
- 76-6425-107
- 76-6425-207
- 65-6003-017
- 65-6003-007
- 10-0270-397
- 10-0172-007

COMPONENTS & ACCESSORIES

6



DESCRIPTION

- 6 EBS-connector cable
Haldex 7 m
- EBS-connector cable
Knorr TEBS G2.1 P. 3 m
- EBS-connector cable
Knorr TEBS G2.2 P. 3 m



PART NO
68-0049-017

68-0111-007

69-0078-017

RDCpremium

RAMP-DISTANCE-CONTROL FOR TRAILER WITH EBS



Driver's sixth sense

Damages occur too frequently while manoeuvring backwards!
RDCpremium, a sixth sense, when combined with trailers EBS systems,
reduces impacts.

24V ELECTRONIC ACCESSORIES

SMCG - SIDE MARKER CONTROL GEAR

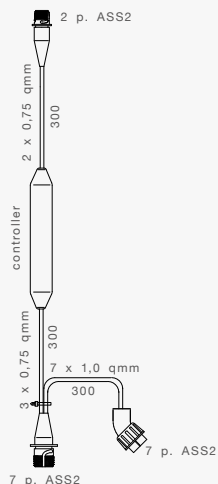

GENERAL DESCRIPTION

- This side marker control gear was developed as a solution for the new revision of ECE 48 to Rev. 6. This regulation provides for that after November 2017 by vehicle O3 and O4 all side markers must flash in simultaneously with the direction indicator in the rear lamp.
- Various ways of solution, which avoid the affixing of additional three CAT 5 direction indicators on each side.
- Easy installation on the vehicle and easy conversion.

- **Solution 1: SMCG** - A separate harness which includes a control gear.

DESCRIPTION

SMCG right
SMCG left
SMCG right + left



PART NO

75-0328-007
75-0329-007
75-0331-007



- **Solution 2: SMCG relay** - A unit which looks like an relay. The „SMCG relay“ gives you the opportunity to fit them into the Aspöck junction boxes or Aspöck rear lamps (Europoint III, Europoint II und Ecopoint II).

DESCRIPTION

SMCG relay



PART NO

12-3970-557

ERD - ELECTRONIC REVERSE LIGHT DEVICE

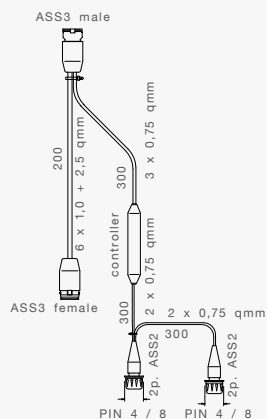

GENERAL DESCRIPTION

- The ERD „Electronic Reverse Light Device“ will allow the additional reversing lights only to come on when reversing whilst the parking lights are also on.
- With the mounting of an additional reversing light, the legal regulations are complied.
- Easy installation on the vehicle and easy conversion.

DESCRIPTION

ERD - electronic reverse light device



PART NO

75-0341-007

ELECTRONIC REVERSING BUZZER

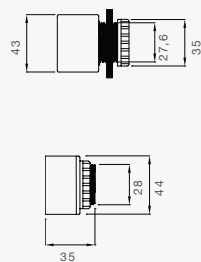

GENERAL DESCRIPTION

- pulsating tone
- volume 98dv on 1m

DESCRIPTION

1,2 m cable and 2 pin ASS1 connector, IP68

3,5 m cable open end, IP68

1,2 m cable open end, IP54

built-in version for

Europoint I & Europoint III

built-in version for Europoint II



PART NO

75-0000-007

75-0100-007

75-0002-007

12-3922-004

12-3922-014

VOLTAGE REDUCER

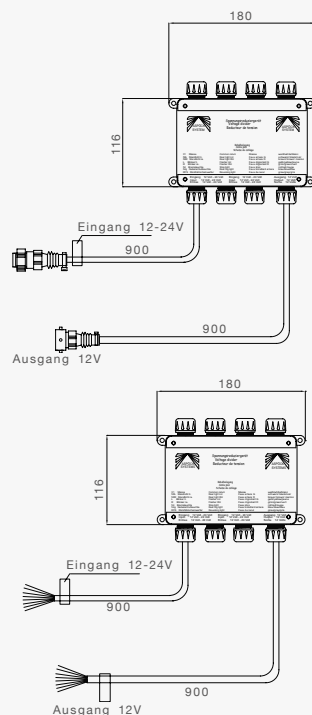

GENERAL DESCRIPTION

- The voltage reducer was designed for trailers with 12V lamps and a towing vehicle with either 24V or 12V.
- Should a short circuit or overloading occur, the appropriate output switches off. The other outputs remain fully functional.
- The voltage reducer is splash-water and dust-protected and fitted with an automatic voltage recognition (that determines whether the input voltage is 12V or 24V, the output voltage remains a constant 12V).

DESCRIPTION

24V to 12V with 15 pin bayonet connection

24V to 12V with open end cables



PART NO

76-9010-007

76-9009-007

24V Spare Parts and Accessories





24V SPARE PARTS AND ACCESSORIES

SPARE PARTS AND CONNECTION ELEMENTS

SYSTEMS ASS3 - BOX PACKING



DESCRIPTION

ASS3 3 pin male
 ASS3 3 pin female
 ASS3 17 pin female
 ASS3 17 pin male



PART NO

13-0332-281
 13-0322-281
 13-1722-001
 13-1732-001

SYSTEMS ASS2 - BOX PACKING



DESCRIPTION

ASS2 SML connection
 ASS2 2 pin male yellow
 ASS2 2 pin male green
 ASS2 2 pin male black
 ASS2 2 pin female yellow
 ASS2 2 pin female green
 ASS2 2 pin female black
 ASS2 7 pin male yellow
 ASS2 7 pin male green
 ASS2 7 pin male white
 ASS2 7 pin male black
 ASS2 7 pin female yellow
 ASS2 7 pin female green
 ASS2 7 pin female white
 ASS2 7 pin female black



PART NO

15-5624-041
 13-5625-871
 13-5625-881
 15-0281-021
 13-5626-341
 13-5626-351
 15-5624-031
 13-5625-831
 13-5625-841
 13-5625-851
 13-5625-861
 13-5626-941
 13-5626-951
 13-5626-961
 13-5626-971

SYSTEMS ASS1 - BOX PACKING



DESCRIPTION

ASS1 2 pin male yellow
 ASS1 2 pin male green
 ASS1 2 pin female yellow
 ASS1 2 pin female green
 ASS1 2 pin female black
 ASS1 7 pin male black
 ASS1 7 pin female yellow
 ASS1 7 pin female green
 ASS1 7 pin female black



PART NO

13-5625-211
 13-5625-231
 13-5626-261
 13-5626-271
 13-5626-331
 13-5625-821
 13-5626-931
 13-5626-921
 13-5626-911

SYSTEMS BAYONET - BOX PACKING



DESCRIPTION

Bayonet 2 pin male green
 Bayonet 2 pin male black
 Bayonet 2 pin female yellow
 Bayonet 2 pin female green
 Bayonet 2 pin female black
 Bayonet 7 pin male grey
 Bayonet 7 pin female white
 Bayonet 7 pin female grey
 Bayonet 8 pin male yellow
 Bayonet 8 pin male green
 Bayonet 8 pin male black
 Bayonet 8 pin female yellow
 Bayonet 8 pin female green
 Bayonet 8 pin female black
 Bayonet 15 pin male
 Bayonet 15 pin female



PART NO

13-0232-031
 13-0236-031
 13-0220-031
 13-0222-031
 13-0226-041
 13-0836-021
 13-0824-031
 13-0826-031
 13-0831-031
 13-0833-031
 13-0838-061
 13-0821-051
 13-0823-041
 13-0828-061
 13-1530-101
 13-1520-051

ASS1 SYSTEMS - PLASTIC BAG



DESCRIPTION

ASS1 2 pin female yellow
 ASS1 2 pin female green
 ASS1 2 pin female black
 ASS1 7 pin female yellow
 ASS1 7 pin female green
 ASS1 7 pin female white
 ASS1 7 pin female black
 15 pin Bayonet male
 15 pin Bayonet female



PART NO

13-5626-204
 13-5626-224
 13-5626-284
 13-5626-704
 13-5626-724
 13-5626-744
 13-5626-784
 13-1530-004
 13-1540-004

24V SPARE PARTS AND ACCESSORIES

REFLECTORS

TRIANGULAR REFLECTOR



DESCRIPTION

screwable

self-adhesive



PART NO

15-5400-007

15-5400-557

REFLECTOR 90 X 40 MM



DESCRIPTION

white, self-adhesive

red, self-adhesive

yellow, self-adhesive

yellow, screwable



PART NO

15-5430-017

15-5431-017

15-5432-017

15-5432-007

REFLECTOR 76 X 34 MM



DESCRIPTION

yellow, self-adhesive

white, self-adhesive

white with bracket



PART NO

15-5435-017

15-5434-017

15-5434-157

REFLECTOR D= 80 MM



DESCRIPTION

white, screwable

red, screwable

yellow, screwable



PART NO

15-5420-007

15-5421-007

15-5422-007

REFLECTOR D= 60 MM



DESCRIPTION

white, screwable

white, self-adhesive

red, screwable

red, self-adhesive

yellow, screwable

yellow, self-adhesive



PART NO

15-5410-007

15-5410-017

15-5411-007

15-5411-017

15-5412-007

15-5412-017

24V SPARE PARTS AND ACCESSORIES

SMARTLINK - SUPERSEAL

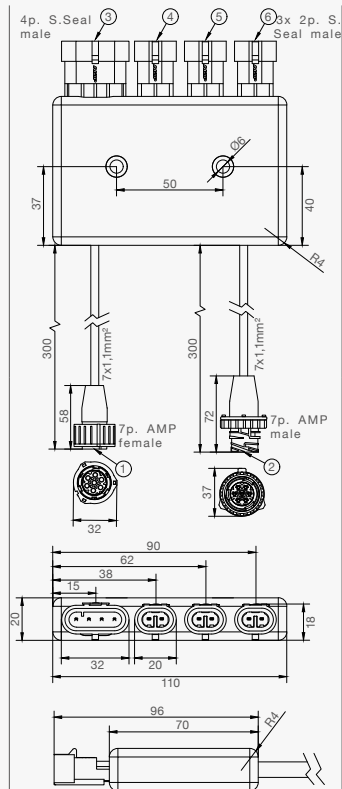

DESCRIPTION

In & Out cable with Amp 7 pin
Outputs:
1x Amp Superseal 4 pin
3x Amp Superseal 2 pin

In & Out cable with open end
Outputs:
1x Amp Superseal 4 pin
3x Amp Superseal 2 pin



PART NO

76-9035-007

76-9035-017

SMARTLINK - ASS3

WITH COILED CABLE

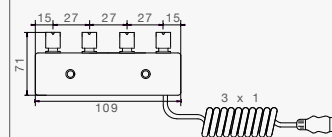

DESCRIPTION

distributor ASS3 with
coiled cable



PART NO

76-9023-007

EXTENSION CABLES

11-CORES (7 x 1 + 1 x 1,5 + 3 x 2,5 QMM)

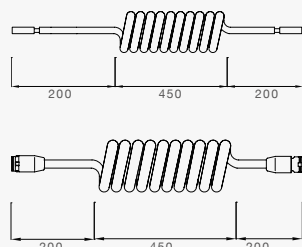

DESCRIPTION

open end, working length 4,5 m
with ASS3 connections,
working length 4,5 m



PART NO

17-7910-507

65-1022-027

MARKER BOARDS

MARKER BOARD 566 x 197 MM



GENERAL DESCRIPTION

- marker board ECE70

DESCRIPTION

one pair (2 pieces) aluminium
566 x 197 x 1 mm



PART NO

14-4200-002

ENLARGEMENTS

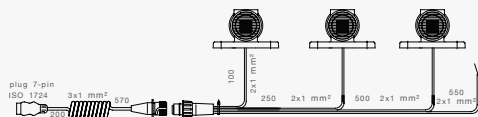
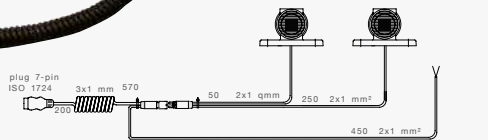

GENERAL DESCRIPTION

- for broadloom trailers
- **ATTENTION** - marker board is not included!

DESCRIPTION

with 2 pieces Superpoint III
LED, with additional exit for
twisting lamp

with 3 pieces Superpoint III
LED, with additional exit for
twisting lamp



PART NO

58-1955-007

58-1957-007

SUPERPOINT III LED

VERSION 3 PIN ASS3 CONNECTION

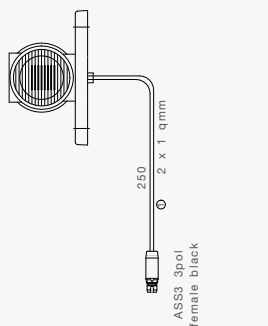

DESCRIPTION

red/white/orange/ left/right
with 0,25 m cable



PART NO

31-3307-087

24V SPARE PARTS AND ACCESSORIES

ISO PLUGS

ISO PLUGS



DESCRIPTION

plug with 7 pins, 24V, ISO 1185, alu housing, with cable glands, single packed in plastic bag

plug with 7 pins, 24V, ISO 3731, alu housing, with cable glands, single packed in plastic bag

plug with 13 pins, 24V, ISO 12098, plastic housing, with grommet

14 pin VBG-plug 24V

15 pin plug 24V, ISO 12098, plastic housing, with grommet



PART NO

13-3020-004

13-3025-004

13-3040-007

13-3150-007

13-3070-007

ISO SOCKETS

ISO SOCKETS



DESCRIPTION

socket with 7 pins 24V, ISO 1185, alu cover

socket with 7 pins 24V, ISO 3731, alu cover

socket with 13 pins 24V, ISO 12098, plastic housing

VBG socket with 14 pins 24V

socket with 15 pins 24V, ISO 12098, plastic housing

socket with 15 pins 24V, ISO 12098, plastic housing, with double exit



PART NO

13-3128-027

13-3129-027

13-3140-007

13-3050-027

13-3170-007

13-3170-057

CONTOUR MARKING TAPE



GENERAL DESCRIPTION

- Unique adhesive layer:
 - Easily and quickly applied without loss of material.
 - The adhesive layer cures into a permanent bond, making the tape repositionable.
- Reflective performance UN/ECE-104 Class C approved:
 - Approved according to european specifications for reflective materials for trucks and trailers.
 - Very high reflective values, especially for larger illumination angles (e.g. 60°).
- Unique prism technology:
 - Layout of the prisms in squares in various orientations.
 - Homogenous horizontal, vertical and diagonal reflection.
- Special composition:
 - Three chemically bound layers making the product thin, flexible and very strong.
 - Impenetrable to water and dirt after cutting or damaging of the product.
 - Contains no air bubbles.
- Acrylate structure:
 - The acrylic top layer offers excellent stability.
 - The structure offers 7 years of proven durability worldwide.

DESCRIPTION

50,8 mm x 50 m white
 50,8 mm x 50 m yellow
 50,8 mm x 50 m red
 for curtainsider
 50,8mm x 50 m white
 for curtainsider
 50,8 mm x 50 m yellow
 for curtainsider
 50,8 mm x 50 m red



PART NO

15-5990-007
 15-5990-107
 15-5990-207
 15-5990-407

 15-5990-507

 15-5990-607

24V Installation Regulations





Legal Installation Regulations for Trailers in Accordance with ECE Regulation No R48

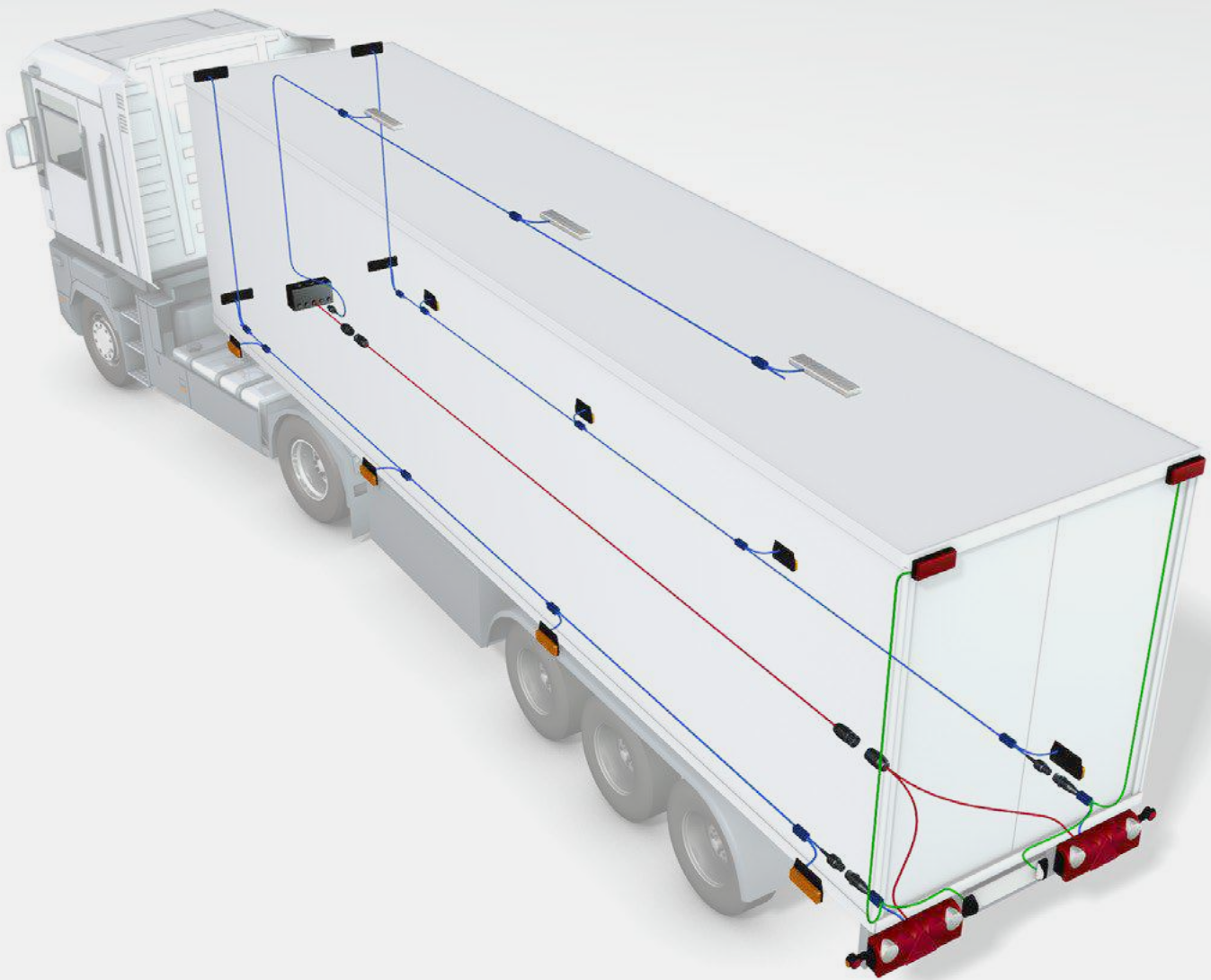

FRONT

1. Front end-outline marker lamp*

Installation:	Mandatory for trailers > 2.1 m wide, Permitted for trailers >1.8 m to < 2.1 m wide.
Number:	2 pieces
Colour:	White
Installation height:	As high as possible.
Spacing:	Mount as far apart as possible to a max. of 400 mm from the furthest point of the vehicle's width.
Geom. angle of visibility:	Horizontally 80° outwards, vertically 5° above and 20° below the horizontal.
Other regulations:	Any front position (side) lamp or reflex reflector may be installed. Additional reflex reflectors are permissible.

*End-outline marker lamps: special regulation for trailers with canopy: On a trailer with a canopy the end-outline marker lamp can only be installed at the bottom. The front white and rear red end-outline marker lamps may be installed in a single lamp provided the installation regulations and angles of visibility are complied with.

O₁ = trailers up to 0.75 t O₂ = trailers from 0.75 t to 3.5 t O₃ = trailers from 3.5 t to 10 t O₄ = trailers over 10 t

2. Front reflex reflector

Installation:	Mandatory for all trailers.
Number:	2 pieces
Colour:	White
Shape:	Not triangular
Installation height:	At least 250 mm, 900 mm max. (exception: 1.500 mm).
Spacing:	There should be a max. of 150 mm and a min. of 600 mm between both reflectors, but at least 400 mm for vehicles with a width of < 1.300 mm.
Geom. angle of visibility:	Horizontally 10° inwards and 30° outwards, vertically ± 10°, but 5° downwards if installation height is < 750 mm.
Other regulations:	The illuminating surface of the reflex reflector may be incorporated in the front position (side) lamp. The installation height of the reflector must be taken into account.

3. Front position (side) lamp

Installation:	Mandatory for trailers > 1.6 m wide, permitted for trailers ≤ 1.6 m wide.
Number:	2 pieces
Colour:	white
Installation height:	At least 350 mm, 1.500 mm max. (exception: 2,100 mm on trailers of the categories O1 and O2 only or on other trailers where a max. of 1.500 mm is not possible).
Spacing:	A max. of 150 mm from the furthest point of the vehicle's width, with a min. of 600 mm between both front position lamps, but of at least 400 mm on vehicles with a width of < 1.300 mm.
Geom. angle of visibility:	Horizontally 5° inwards and 80° outwards. Vertically ± 15°, but also 5° downward if installation height is < 750 mm.
Other regulations:	The illuminating surface of the reflex reflector may be incorporated in the front position (side) lamp. The installation height of the reflector must be taken into account.

SIDE

4. Side reflex reflector

Installation:	Mandatory for all trailers.
Number:	At least one in the middle third.
Colour:	Yellow
Installation height:	At least 250 mm, 900 mm max. (exception: 1.500 mm).
Spacing:	No more than 3 m from front (including drawbar); no more than 1 m from rear, no more than 3 m between each reflector (exception: 4 m).
Geom. angle of visibility:	Horizontally ± 45°, vertically ± 10°, but 5° downwards if installation height is < 750 mm.
Other regulations:	The illuminating surface of the reflex reflector may be incorporated in the side-marker lamp. The max. installation height of the reflector must be taken into account.

5. Side-marker lamp

Installation:	Mandatory for trailers > 6 m long, permitted for trailers < 6 m long.
Number:	At least one in the middle third.
Colour:	Yellow in front, yellow at rear (red also possible in combination with the rear light).
Installation height:	No more than 3 m from front (including drawbar), no more than 1 m from rear, no more than 3 m between each side-marker lamp (exception: 4 m).
Geom. angle of visibility:	Horizontally $\pm 45^\circ$, vertically $\pm 10^\circ$, but 5° downwards if installation height is < 750 mm .
Other regulations:	The illuminating surface of the reflex reflector may be incorporated in the side-marker lamp. The max. installation height of the reflector must be taken into account.

Note: side-marker lamp: intensity of light emitted at least 4cd = for trailers of every category

REAR

6. Direction indicator lamps

Installation:	Mandatory for all trailers, category 2a or 2b.
Number:	2 pieces
Colour:	Yellow
Installation height:	At least 350 mm, 1.500 mm max. (exception: 2.100 mm only if no two additional direction indicator lamps have been installed). Installation height of additional direction indicator lamps: at least 600 mm above the mandatory direction indicator lamps.
Spacing:	No more than 400 mm from the furthest point of the vehicle's width. This does not apply to the additional direction indicator lamps. There should be at least 600 mm between the two direction indicator lamps, but at least 400 mm on vehicles < 1.300 mm wide.
Geom. angle of visibility:	Horizontally 45° inwards to 80° outwards, vertically $\pm 15^\circ$, but also 5° downwards if installation height is < 750 mm.
Other regulations:	Installation of two additional direction indicator lamps (2a or 2b) is permitted on all trailers in the categories O_2 , O_3 and O_4 .

7. Rear tail lamp

Installation:	Mandatory for all trailers.
Number:	2 pieces
Colour:	Red
Installation height:	At least 350 mm, 1.500 mm max. (exception: 2.100 mm only if no two additional rear lamps have been installed). Installation height of the additional rear lamps: at least 600 mm above the mandatory rear lamps.
Spacing:	A max. of 400 mm from the furthest point of the vehicle's width. This does not apply to the additional rear lamps. There must be at least 600 mm between the two rear lamps, but at least 400 mm if the vehicle is < 1.300 mm wide.
Geom. angle of visibility:	Horizontally 45° inwards to 80° outwards, vertically $\pm 15^\circ$, but also 5° downwards if installation height is < 750 mm.
Other regulations:	Unless end-outline marker lamps are installed, two additional rear end-outline lamps may be installed on all trailers of the categories O_2 , O_3 and O_4 .

8. Stop lamp

Installation:	Mandatory for all trailers, category S1 or S2.
Number:	2 pieces. Unless category S3, S4 stop lamps have been installed, two additional stop lamps of the category S1 or S2 may be installed on vehicles of the categories O ₂ , O ₃ and O ₄ .
Colour:	Red
Installation height:	At least 350 mm, 1.500 mm max. (exception: 2.100 mm only if no two additional stop lamps have been installed). Installation height of the additional stop lamps: at least 600 mm above the mandatory stop lamps.
Spacing:	On all trailers at least 600 mm between the two stop lamps, but at least 400 mm if the vehicle is < 1.300 mm wide.
Geom. angle of visibility:	Horizontally ± 45°, vertically ± 15°, but also 5° downwards if the installation height is < 750 mm.
Other regulations:	The distance between the S1 or S2 stop lamp and the rear fog lamp must be > 100 mm.

9. Reversing light

Installation:	Mandatory for all trailers of vehicle categories O ₂ , O ₃ and O ₄ , permissible for trailers of vehicle category O ₁
Number:	1 piece light is mandatory, a second permissible on trailers < 6 m long. 2 lights mandatory on vehicles > 6 m long, and 2 additional reversing lights permissible on all other trailers.
Colour:	White
Installation height:	At least 250 mm, 1.200 mm max.
Spacing:	No regulations apply
Geom. angle of visibility:	1 light: horizontally ± 45°. 2 lights: horizontally 30° inwards to 45° outwards. Vertically 15° upwards to 5° downwards.
Other regulations:	Installation of additional reversing lights on the vehicle is possible at the rear or on the sides.

10. Rear fog lamp

Installation:	Mandatory for all trailers.
Number:	1 piece or 2 pieces
Colour:	Red
Installation height:	At least 250 mm, 1.000 mm max.
Spacing:	No regulations apply.
General regulations for installation:	In the case of 1 rear fog lamp: left of centre for left-hand drive vehicles, right of centre for right-hand drive vehicles. Centre installation permissible.
Geom. angle of visibility:	Horizontally ± 25°, vertically ± 5°.
Circuit-closed tell-tale:	Mandatory. An independent, non-flashing tell-tale.
Other regulations:	Distance from the stop lamp must be > 100 mm.

11. End-outline marker lamp *

Installation:	Mandatory for trailers > 2.1 m wide. Permissible for trailers > 1.8 m to 2.1 m wide.
Number:	2 pieces statutory, 2 optional
Colour:	Red
Installation height:	As high as possible.
Spacing:	As near the widest point of the vehicle as possible, a max. of 400 mm from the furthest point of the vehicle's width.
Geom. angle of visibility:	Horizontally 80° outwards. Vertically 5° above and 20° below the horizontal.
Other regulations:	The rear red and front white end-outline marker lamps may be installed in a single lamp provided the installation regulations and angles of visibility are complied with. The distance between the end-outline marker lamp and the rear lamp must be at least 200 mm. Any rear light or rear reflex reflector may be used. Additional reflectors are permitted.

*End-outline marker lamps: special regulation for trailers with canopy:

On a trailer with a canopy the end-outline marker lamp can only be installed at the bottom. The front white and rear red end-outline marker lamps may be installed in a single lamp provided the installation regulations and angles of visibility are complied with.

12. Rear reflex reflector

Installation:	Mandatory for all trailers.
Number:	2 pieces
Colour:	Red
Shape:	Triangular
Alignment:	The tip of the triangle must point upwards.
Installation height:	At least 250 mm, 900 mm max. (exception: 1.500 mm).
Spacing:	No more than 400 mm from the furthest point of the vehicle's width, with at least 600 mm between both reflectors, but at least 400 mm if the vehicle is < 1.300 mm wide.
Geom. angle of visibility:	Horizontally ± 30°. Vertically ± 15°, but 5° downwards if the installation height is < 750 mm.
Other regulations:	A rear light with an incorporated rectangular reflex reflector is permitted on trailers. Additional reflex reflectors are permitted.

13. Registration plate lamp

Installation:	Mandatory for all trailers.
Number:	1 piece or more
Colour:	White
Installation height:	at least 350 mm to bottom edge triangle, max. 900 mm to top triangle (exception: 1.500 mm)
Position:	Central or on the left (or right on right-hand drive vehicles).

14. High-mounted stop lamp

Installation:	Permitted on all trailers, category S3.
Number:	1 piece If the vehicle's median longitudinal plane does not pass through a solid rear panel but is, for instance, divided by doors leaving no room for an S3 stop lamp, it is permissible for two S3 stop lamps of the stop lamp type „D“ or for one S3 stop lamp to be installed to the left or the right of the vehicle's median longitudinal plane.
Colour:	Red
Installation height:	At least 350 mm, 1.500 mm max. (exception: 2.100 mm only if no two additional rear lamps have been installed). Installation height of the additional rear lamps: at least 600 mm above the mandatory rear lamps.
Spacing:	The point of reference must be the in the trailer's median longitudinal plane. If two S3 stop lamps have been installed each one must be installed as near as possible to the median longitudinal plane. If only one S3 stop lamp is installed next to the median longitudinal plane the distance must be no greater 150 mm.
Geom. angle of visibility:	Horizontally $\pm 10^\circ$ Vertically 10° above and 5° below the horizontal.

24V Attachments





PART NUMBERS SUMMARY

PART NO	PAGE	PART NO	PAGE	PART NO	PAGE	PART NO	PAGE	PART NO	PAGE
35-0203-127	23	36-3810-007	58	39-8900-007	66	68-7503-027	71	97-1257-007	80
35-0203-137	23	36-3864-007	58	39-8900-057	66	68-7503-177	76	97-1267-007	80
35-0203-147	22	36-3864-017	58	39-8900-107	66	69-0001-004	76	97-1269-007	80
35-0204-007	22	36-3865-007	58	39-8900-157	66	69-0002-004	76	97-1270-007	80
35-0204-017	22	36-3867-017	58	39-8900-207	66	69-0003-004	87	97-1279-007	86
35-0204-027	22	36-3867-027	58	39-8900-257	66	69-0078-017	89	99-3010-201	86
35-0204-037	22	37-7200-007	26	39-8900-307	66	75-0000-007	86	99-3010-221	86
35-0204-047	23	37-7207-007	34	39-8900-357	66	75-0001-007	89	99-3010-241	86
35-0204-057	23	37-8007-157	28	39-8900-407	70	75-0002-007	89	99-3010-251	86
35-0204-067	23	37-9207-017	27	53-1667-037	70	75-0100-007	86	99-3010-281	86
35-0204-077	23	37-9220-007	27	53-6768-007	97	75-0201-617	86	99-3010-291	
35-0204-087	23	37-9230-007	26	58-1955-007	97	75-0204-117	84		
35-0204-097	23	38-7200-007	26	58-1957-007	76	75-0300-107	13		
35-0204-107	23	38-7207-007	34	58-3008-007	70	75-0309-001	85		
35-0204-117	23	38-8007-167	32	58-6024-017	70	75-0309-007	85		
35-0204-127	23	38-8107-067	65	58-6647-007	70	75-0310-007	88		
35-0204-137	23	38-8200-007	65	58-6649-007	70	75-0328-007	88		
35-0204-147	60	38-8207-007	64	65-1003-007	70	75-0329-007	88		
36-3004-017	59	38-8220-007	64	65-1003-017	70	75-0331-007	88		
36-3004-027	59	38-8221-007	64	65-1003-027	70	75-0341-007	77		
36-3004-057	59	38-8221-107	32	65-1005-007	70	76-5100-007	77		
36-3007-007	59	38-8407-007	65	65-1005-017	70	76-5100-047	77		
36-3007-047	59	38-9000-007	65	65-1005-027	70	76-5123-007	85		
36-3007-057	59	38-9007-007	65	65-1007-007	70	76-5132-017	86		
36-3007-397	59	38-9007-017	65	65-1007-017	70	76-6425-107	86		
36-3604-007	58	38-9100-007	65	65-1007-027	96	76-6425-207	77		
36-3604-017	58	38-9107-007	65	65-1022-027	73	76-6430-007	76		
36-3604-027	58	38-9107-017	28	65-1499-007	73	76-7001-007	76		
36-3607-007	58	38-9207-017	27	65-1499-017	86	76-7002-007	76		
36-3607-017	58	38-9220-007	27	65-6003-007	86	76-7037-007	76		
36-3607-027	58	38-9230-007	27	65-6003-017	72	76-7072-007	89		
36-3760-017	61	38-9231-007	63	65-6101-027	72	76-9009-007	89		
36-3764-007	61	39-6400-017	63	65-6499-007	26	76-9010-007	96		
36-3764-017	61	39-6407-007	63	65-6502-017	72	76-9023-007	28		
36-3764-027	61	39-6800-017	63	66-8892-007	87	76-9027-007	28		
36-3767-007	61	39-6807-007	32	68-0049-017	87	76-9028-007	96		
36-3767-017	61	39-7007-007	33	68-0111-007	72	76-9035-007	96		
36-3767-027	59	39-7007-007	33	68-4980-037	71	76-9035-017	62		
36-3804-007	58	39-7007-007	67	68-4983-007	50	87-1272-004	71		
36-3804-017	58	39-8700-017	67	68-5018-007	71	87-1284-007	71		
36-3805-007	58	39-8704-007	67	68-7503-007	71	87-1285-007	72		
36-3806-007	58	39-8704-017	66	68-7503-017	71	87-1286-007	80		

24V ATTACHMENTS

WIRING DIAGRAM

pin assignment	electric circuit functions	Colour (change-ment at each pin. location)	DIN NR.	17p. ASS3	15p. ISO 12098	Bay-Con. 15p	Junction box ASS1	7p. ISO 1185	Bay-Con. 7p. GREY	ASS1/2 7p. BLACK	7p. ISO 3731	Bay-Con. 7p. WHITE	ASS1/2 7p. WHITE	Bay-Con. 8p. BLACK	ASS1/2 7p. YE, GN	Bay-Connector 5p. BLACK		ASS1/2 2p. BLA, YE, GN	ISO 12098 13p. 24V	ISO 1724 7p.	ISO 11446 13p. 12V	ASS3 3p.
																Bay-Con. 5p. yellow (left)	Bay-Con. 5p. green (right)					
RDI LHS		YE	L	1	1	3									1	BL	-	-	3	1	1	-
RDI RHS		GN	R	2	2	5									4	-	BL	-	5	4	4	-
rear fog lamp		BL „S“54g	3	3	3	-					7				2	S	-	-	9	(2)	2	-
earth		WH	31	4	4	1									3	31	31	1	1	3	3	1
tail light left		BK	58L	5	5	2									7	UR	-	-	2	7	7	-
tail light right		BN	58R	6	6	6									5	-	UR	-	6	5	5	-
stop/Brake light		RD	54	7	7	4									6	BR	BR	-	4	6	6	-
reversing light		GY	„S“L	8	8	-					3				8	-	S	-	8	-	8	-
feed current (+)		BN/BU	„S“54	9	9	-					4				-	-	-	-	10	-	9	-
wear control		BN/RD	-	10	10	-					-				-	-	-	-	-	-	10	-
trailer brake control		YE/BK	54g	11	11	7					-				-	-	-	-	7	(2)	*	-
bogge lift		PK	„S“58R	12	12	-					6				-	-	-	-	13	-	-	-
earth for electronics		WH/BK	„S“31	13	13	-					1				-	-	-	-	-	-	13	-
data line		VT	„S“58L	14	14	-					2				-	-	-	-	11	-	-	-
data line		OG	„S“R	15	15	-					5				-	-	-	-	12	-	-	-
free		VT/GN	-	16	-	-					-				-	-	-	-	-	-	-	-
free		OG/BU	-	17	-	-					-				-	-	-	-	-	-	-	-
current-carrying		div.	-	-	-	-					-				-	-	-	2	-	-	-	2/3

APPROVAL NUMBERS 24 V

Rear lamps / bulb	
3 chamber lamp	E9_5520
Earpoint I	E9_1057
Ecoflex	E9_1853
Ecopoint I	E9_5266
Ecopoint I without triangle	E9_5266
Ecopoint II	E9_1853
Ecopoint II without triangle	E9_6246
Eurofab	E9_1211
Europoint III	E9_6984 E9_6985
Europoint II	E9_5497 E13_1787
Europoint I	E9_5167 E2_7078

Rear lamps / LED	
3 chamber lamp LED	E9_6556 E9_1139 E4_23271 E9_5595 E9_1490 E4_13992 E4_4052
Braspoint 98 horizontal vertical	E9_11417 E9_11875 E9_11874 E9_11873 E9_11418 E9_11419
Braspoint 140	E9_11412 E9_11416 E9_11876 E9_11887
EcoLED	E9_1854
EcoLED II	E9_22480
Ecopoint I LED	E9_5266
Ecopoint II LED	E9_11865 E24_1804
Ecopoint II LED without triangle	E9_11866
Europoint III LED	E9_11093 E9_11094
Europoint II LED	E9_5497
MiniLED II	E9_6535 E9_6532 E9_6530 E9_6531
MultiLED	E9_1599 E9_1600
MultiLED II	E24_6110
Multipoint LED	E9_5186
Multipoint V LED	E9_5946
Linepoint I	E24_0145 E24_6109
Linepoint II	E9_11442 E9_11443

Position lamps / bulb	
Flexipoint I red	E9_5332
Flexipoint I white	E9_5332
Monopoint	E4_7740
Sidepoint white	E13_0484 E13_9592

Position lamps / LED	
Flatpoint I white LED	E24_6094
Flatpoint II red LED	E9_5499
Flatpoint II white LED	E9_5499
Monopoint II red LED	E9_5594
Monopoint II white LED	E9_5594
Posipoint II white LED	E9_5593
Posipoint II red LED	E9_5593
Unipoint I red LED	E9_5409
Unipoint I white LED	E9_5409

Side marker lamps / bulb	
Sidepoint	E13_9592

Side marker lamps / LED	
Flatpoint I LED	E24_6094
Flatpoint II LED	E9_5499
Unipoint I LED	E9_5409

End outline marker lamps / bulb	
Flexipoint I red / white	E9_5532
Superpoint I	E13_0339 E13_2317
Superpoint II	E9_5315

End outline marker lamps / LED	
Superpoint III LED	E9_1469
Superpoint IV LED	E9_6878

Number plate lamps / LED	
Regpoint	E9_4127 E9_4135
Regpoint red	E9_4059 E9_4127
Regpoint small	E20_9944

Number plate lamps / LED	
Number plate pad include 2 x NPL LED	E9_1558
Regpoint LED	E9_4133
Regpoint II LED	E4_4352

Additional lamps	
3rd stop lamp	E9_4075
3rd stop lamp „LED“ with Registration Plate	E9_4075

Working-revers lamp	
Reverse-working lamp	E9_4013 E9_1014
Reversing lamp LED oval	E9_6989
Workpoint LED 650	E13_12435
Workpoint LED 800	E13_12438
Workpoint LED 1500	E9_1228
Workpoint LED 3000	E9_1393

Interior lamps	
Interior Lamp LED round	E24_0976
Inpoint III LED without switch	E9_1439 E9_1440
Inpoint III LED with switch	E9_1439 E9_1440
Inpoint III LED with motion sensor	E9_1439 E9_1440
LED-Interior Lamp	E24_0976

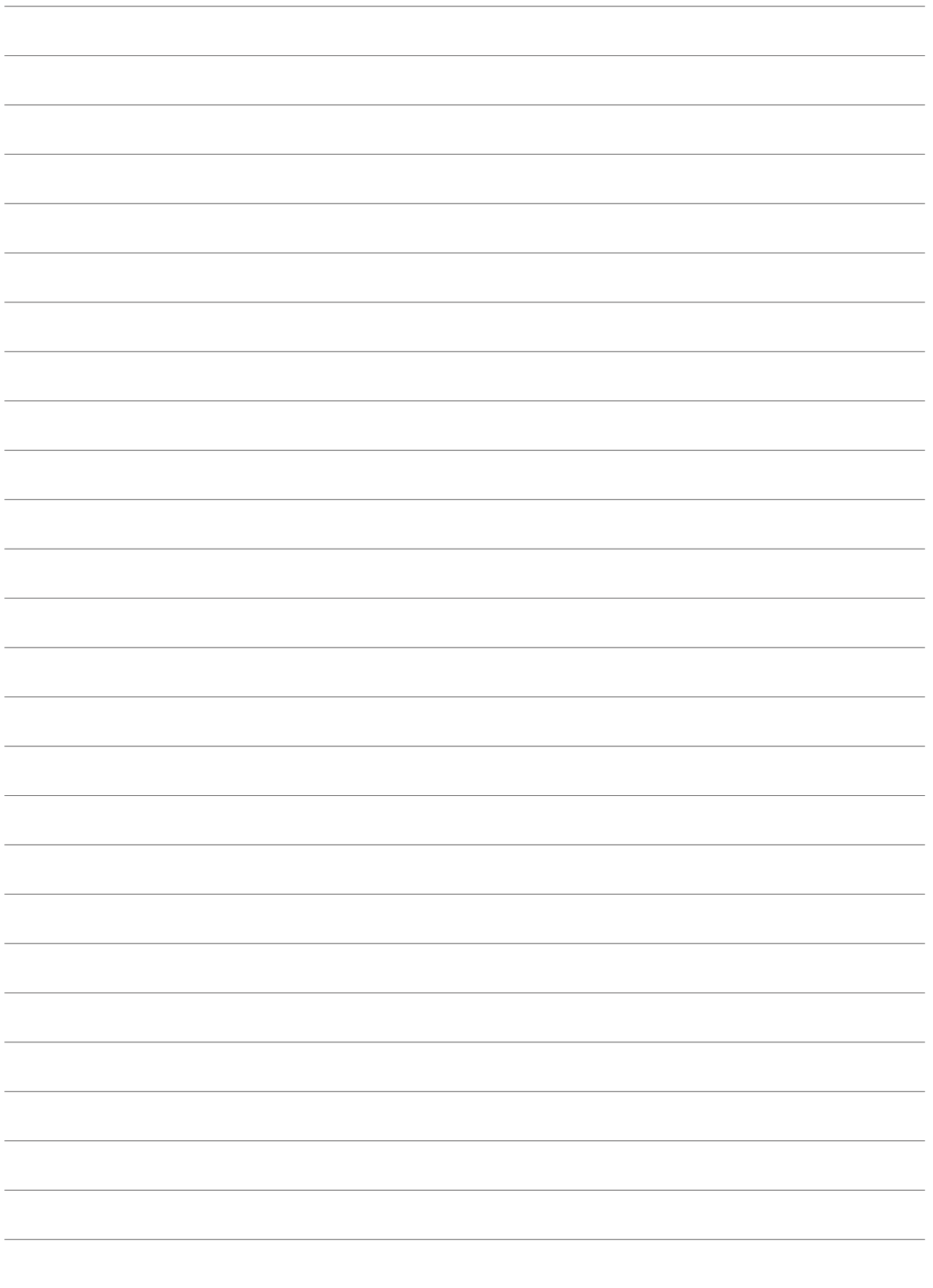

THE ART OF LIGHTS

Aspöck Systems GmbH

Enzing 4 | 4722 Peuerbach | AUSTRIA
Phone.: +43 72 76 / 26 70-0 | Fax: DW 1199
E-Mail: office@aspoeck.at | www.aspoeck.com



10-0365-107
ASP_24V_18_E_122019
Printing errors, technical changes
as well as picture changes reserved.
© Aspöck Systems GmbH

UNITED KINGDOM, EIRE

Aspöck UK Ltd.
Unit 19, Stansted Distribution Centre
Great Hallingbury
Bishops Stortford, Herts
GB-CM22 7DG
Tel.: +44 1279 655 220
Fax: +44 1279 505 869
E-Mail: sales@aspoeck.co.uk
www.aspoeck.co.uk

FRANCE, LUXEMBOURG, ALGERIA, MOROCCO, TUNISIA

Aspöck France S.A.S.
ZAC Bel Air
260 Rue des Vergers
F-69480 Pommiers
Tel.: +33 437 5508 65
Fax: +33 437 5508 97
E-Mail: office@aspoeck.fr

SPAIN, PORTUGAL

Aspöck Iberica
Via Sergia, 32 Nave N° 2
Poligono Industrial
"Les Hortes del Cami Ral"
E-08302 Mataro (Barcelona)
Tel.: +34 937 598 039
Fax: +34 937 501 033
E-Mail: aspock@aspock.com
www.aspock.com

SWEDEN, FINLAND, NORWAY, DENMARK, ESTONIA

Aspöck Norden AB
Birger Svenssons väg 16E
SE-432 40 Varberg
Tel.: +46 340 483 870
Fax: +46 340 483 879
E-Mail: info@aspoeck-norden.se

ITALY

PAGG Aspöck srl
Via Legnano, 8
I-20835 Muggiò (MB)
Tel.: +39 039 278 5255
Fax: +39 039 278 9582
E-Mail: info@aspoeck.it

BRAZIL

Aspock do Brasil Ltda.
Estrada RS 122 km 88,5 S/N
Bairro São Gotardo
Flores da Cunha-RS
CEP 95270-000
Tel.: +55 54 3039-5400
E-Mail: contato@aspock.com.br

POLAND, LITHUANIA, LATVIA, UKRAINE

Aspöck Systems Polska Sp.z.o.o.
ul. Byczyńska 10
46-320 Praszka
Tel.: +48 34 3430 600
Fax.: +48 34 3430 609
E-Mail: office.poland@aspoeck.com

TURKEY, MIDDLE EAST

Aspöck Aydınlatma Sistemleri Tic. Ltd.
Feneryolu Mah. Yıldıray Sok.
No 20/B P.K: 34724
Kadıköy / Istanbul
Turkey
Tel.: +90 (0) 216 5105400-3 lines

GERMANY

Suer GmbH & Co KG
Handelsstraße 5
D-42929 Wermelskirchen
Tel.: +49 2196 946 0
Fax: +49 2196 946 100
E-Mail: info@suer.de

GERMANY

Hofmeister & Meincke
Carsten-Dressler-Straße 6
D-28279 Bremen
Tel.: +49 421 8405 296
Fax: +49 421 8405 201
E-Mail: bremen@hofmei.de

AUSTRIA, HUNGARY, CROATIA, CZECH REPUBLIC,

Ing. A. F. Baeder Ges.m.b.H.
Kolpingstraße 13
A-1230 Wien
Tel.: +43 1 865 16 40
Fax: +43 1 869 22 12
E-Mail: sales@baeder-automotive.com

AUSTRIA (ONLY 12V)

Knott Handelsges.m.b.H.
Rennweg 79-81
A-1030 Wien
Tel.: +43 1 714 22 22
Fax: +43 1 714 22 33
E-Mail: info@knott.at

SWITZERLAND

AGL AG für Lastwagenzubehöre
Müslistrasse 43
CH-8957 Spreitenbach
Tel.: +41 41 348 04 80
Fax: +41 41 340 31 79
E-Mail: info@agl.ch

NETHERLAND, BELGIUM

Frits Dijk International
Collse Heide 64
NL-5674 VN Nuenen
Tel.: +31 40 2831815
Fax: +31 40 2838717
E-Mail: info@fritsdijk.nl

SERBIA, ROMANIA, BULGARIA, SLOVAKIA

Ing. A. F. Baeder Ges.m.b.H.
Kolpingstraße 13
A-1230 Wien
Tel.: +43 1 865 16 40
Fax: +43 1 869 22 12
E-Mail: sales@baeder-automotive.com

MONTENEGRO, SLOVENIA, BOSNIA AND HERZEGOVINA

Ing. A. F. Baeder Ges.m.b.H.
Kolpingstraße 13
A-1230 Wien
Tel.: +43 1 865 16 40
Fax: +43 1 869 22 12
E-Mail: sales@baeder-automotive.com

ISRAEL

M.N. Systems
Pier St., Industrial Park Emek 10
Hefer, IL-3877701
P.O.B 12186
Tel.: +97 24 6220 111
Fax: +97 24 6220 808
E-Mail: info@mnsys.co.il

EAST ASIA

JM Company
312-15, Jaedurumi-gil
Paju-si, Gyeonggi-do
10863, S. Korea
Tel.: +82 31 944 7670
Fax: +82 31 947 7671

RUSSIA, KYRGYZSTAN, MONGOLIA, BELARUS, KAZAKHSTAN

STAT Ltd
RUS, 125464, Moscow region,
Volokolamskoe Highway
House 142
Pom. I, Room 35, Office 535
Tel.: +7 (495) 739-03-47
E-Mail: info@stat-parts.ru

SOUTH AFRICA, BOTSWANA, LESOTHO, NAMIBIA, ZIMBABWE, ESWATINI

Trail-Link South Africa
699 Seccull Avenue
0084 Mayville, Pretoria
P.O.B. 880
Gauteng / South Africa
Tel.: +27 12 335 7402
E-Mail: sales@trail-link.co.za