

# The **Haldex** Aftermarket Quick Reference Catalog



Quality parts for vehicles at any life stage.

- Actuators • Air Disc Brakes • Air Treatment/Airline • Air Valves
- Anti-Lock Brake Systems (ABS) • Brake Adjusters
- Clutches • Compressors • Electrical • Friction
- Remanufactured Products • Suspension Valves • Water Pumps

**MIDLAND™**

**Haldex**

**Like-Nu™**

✦ **Competitor Products and Trademarks:** In addition to Haldex's own products, Haldex remanufactures the products of various other companies in the industry ("competitor products") including the following brands: Carrier, Bendix®, Ford, Caterpillar, Mack, Cummins, Detroit Diesel, CAT, WABCO, Meritor, Sealco, Primus, Voyager, Kenworth, Navistar, Peterbilt, Mack, GMC (General Motors), Chevy, Dodge, Ford, DDC, Isuzu, MAN, Mercedes, Navistar, Perkins, Renault, Crane, Delco, Leece- Neville, Motorola, Horton, Gold Top, Dayton, Sprague, Trico, Thermo-King, TRW, Saginaw, Hobourn/Eaton, Vickers, Fruehauf, Dana, Dana Spicer, Spicer, Dexter, Vibra Seal, SKF, NOVA Bus, New Flyer Bus, Easy-Stop, LIPE, Lucas Girling, and Eaton. All trade names and trademarks associated with those competitor products referenced in this catalog are the property of the respective competitors or their licensors. Haldex's use of the competitor names and marks is solely for the purpose of describing the origin of the products or intended use. None of these competitors are affiliated with Haldex, nor are we, our products or this catalog sponsored by them.

## **Important Notice**

The products described within this literature, including without limitation, product features, specifications, designs, availability and pricing are subject to change by Haldex and its subsidiaries at any time without notice.

This document and other information from Haldex, its subsidiaries and authorized distributors provide product and/or system options for further investigation by users having technical expertise. It is important that you analyze all aspects of your application and review the information concerning the product or system, in the current literature or catalog. Due to the variety of operating conditions and applications for these products or systems, the user, through their own analysis and testing, is solely responsible for making the final selection of the products and systems and assuring that all performance, safety and warning requirements are met.

# Table of Contents

Description	PAGE
New & Remanufactured Compressors, Kits, Governors & Air Cleaner	2
Air Valves	5
Suspension Valves	12
Actuators, Maxibrakes, Service Chambers, Replacement Parts	15
Electrical Products, Switches, Primary Wire, Brake Controllers, Battery Hardware	21
GeminiMDx Dual Air Drying System, Air Treatment Products	27
Reman Carrier A/C Compressors	31
Gladhands, Gladhand Grips, Reservoirs, Air Hoses, Coiled Air Hoses, Flexastiks	32
Brake Adjusters (Manual, AA1, S-ABA)	35
Air Disc Brakes (ModulT, ModulX)	37
Water Pumps (New & Remanufactured)	38
Anti-Lock Brake Systems (ABS)	40
Clutches (New & Remanufactured)	47
Midland Flywheels, Midland Pilot Bearings	50
Remanufactured Products Alternators, Starters, Brake Calipers, Steering Gears & Pumps, Air Wiper Motors, Air Control Valves, Vacuum Boosters	52
Midland Air Brake Disc Pad Replacement Kits	55
RSD Complete Fleet Solutions	60
Grey-Rock Brake Block/Lined Shoe Descriptions	62
Grey-Rock Brake Shoes (Most Popular Styles)	64
Brake Hardware Kits	68
TransitmaX High Performance Brake Lining	69

Copyright 2019  
Haldex Brake Products Corporation  
10930 North Pomona Avenue  
Kansas City, Missouri 64153  
All rights reserved.

Materials may only be reproduced with written permission of Haldex.

**Any Part Number throughout this Catalog with a Suffix "X"  
is Considered a Remanufactured Part.**

# Remanufactured Haldex Compressors



EL740 - 7.4 CFM



EL850 - 8.5 CFM



EL1300 - 12.9 CFM



EL1600 - 16.1 CFM



EL3200 - 32.2 CFM

Haldex air compressors are designed for use in heavy duty vehicle air brake systems.

The EL1300/EL1600 are water cooled, two-cylinder, reciprocating piston type compressors designed for high performance with maximum durability for extended life.

The EL1600 is identical to the EL1300 except for the increased stroke which is achieved by increasing the crankshaft throw. The height of the compressor is increased by .19 inches.

The EL3200 is two twin cylinder EL1600 compressors assembled in-line and is designed for use on vehicles with a high air volume requirement for special accessory equipment requirements in addition to the air brake system.

The EL850 is a single cylinder compressor offered in water-cooled or air-cooled versions.

The EL740 compressors are offered in water-cooled or air-cooled versions and accommodate belt-driven or gear-driven mounting requirements for most gasoline and diesel engines.

All compressors are available remanufactured. Some older EL compressors may not be available in new product and may only be available in remanufactured form.

## Identification Information

### REMANUFACTURED PART NUMBERS

Any part number throughout this catalog with the "X" Suffix is considered a Remanufactured Part.

### COREFREE PART NUMBERS

Any part number throughout this catalog with the "RX" Suffix is CoreFree. These parts require no core. The part you are looking for may be available CoreFree. Please contact your Customer Service Representative for current availability.

### COMPRESSOR PORTING REFERENCES

Porting references on Bendix® compressors are looking at the "non-drive" end of the compressor.

Porting references on Haldex compressors are looking at the drive end of the compressor. Heads on Haldex compressors may be rotated unless otherwise noted.

# Flange and Engine +

ENGINE -		PART #
Standard Belt Drive		
	With Spec. Ford Bottom Plate	EL13022X
	Standard Belt Drive	EL13060X
	Standard Belt Drive	EL16060X
	Air Cooled Single Cylinder	KN85020X
	Water Cooled Single Cylinder	KN86020X
	Caterpillar 1673, 1674, 3406B	EL13080X EL13081X EL16080X
	Caterpillar 3406-E240 Spline	EL13120RX, EL13120X EL16120X
	Caterpillar 3406-E324 Taper	EL13170X
	Caterpillar 3406B-E324 Taper	EL13200RX, EL13200X EL16200X
	Mack In-Line Six (*Do Not Turbo-Charge Mack Compressors)	EL13111X* EL14111X EL16111X
	Caterpillar 3306	EL13151RX, EL13151X
	Cummins In-Line (Double Flange)	EL13040X EL16040X
	Cummins Type "B" Engines	KNT85230X KNT86230RX KNT86230X
	Cummins Type "C" Engines	EL13220X
	Detroit Diesel 0°	EL13050X EL16050X
	Detroit Diesel 41°	EL13090X
	Detroit Diesel 45°	EL13160X EL16160X
	Detroit Diesel 50°	EL13100X EL16100X
	Detroit Diesel 75°	EL16250X
	Detroit Diesel 60 Series	EL13312X EL16312X

# Remanufactured Competitor Compressors +

## Bendix®



103274X



109139X



286528X



5004187X



5004188X

Service Part No.	Model	Description	Cooling	Air Inlet	Air Outlet	Notes
103274X	TF501	CAT 3406B - Flange Mount	Water/Air	Left	Top	Threaded Discharge
109139X	TF550	CAT 3406, C10, C12, C15, C16 - Flange Mount	Water	Left	Left/Top	Crankshaft Thread
286528X	TF501	Base Mount	Water/Air	Left	Top	Threaded Discharge
5004187X	TF750	Detroit 0° Tilt - Flange Mount	Water/Air	Right	Top/Right	60 Series Adapterless
5004188X	TF550	Detroit 0° Tilt - Flange Mount	Water/Air	Right	Top/Right	60 Series Adapterless

## CATERPILLAR

(only available through CAT and Haldex)



EL365007X



EL365132X



EL365152X

Service Part No.	Description	Notes (Specifications apply to all Part Numbers Listed)
EL365007X	CAT EL365 - 2-Hole Mount	Head Rotation: Rear / Block Rotation: Right Naturally Aspirated: High Air Output Thru-Drive: 11 Tooth, 150 ft lb Torque Pressure Relief Valve: Included All Units Inlet Check Valve: Included Units 2007 After
EL365131X	CAT EL365 - 3-Hole Mount C13 (Pre 2007)	
EL365132X	CAT EL365 - 3-Hole Mount C13 (2007 After)	
EL365151X	CAT EL365 - 3-Hole Mount C15 (Pre 2007)	
EL365152X	CAT EL365 - 3-Hole Mount C15 (2007 After)	

## CUMMINS



3018543X



3049186X



3558052X



3558072X



3558074X

Service Part No.	Model	Description	Air Inlet	Air Outlet	Unloader Port/Type	Notes
3018543X	SS296 Super Single Cylinder	Standard Case	Left	Rear	Left/Direct	For L/K/N Engines
3049186X	SS296 Super Single Cylinder	Standard Case	Left	Rear	Left/Direct	Square Flange Crankcase
3558052X	QE296C Econo Single Cylinder	C-Series	Left	Front	n/a	Iron Head/Cover
3558072X	QE296 Econo Single Cylinder	L10/N14	Left	Rear	n/a	Iron Head/Cover
3558074X	QE338 Econo Single Cylinder	E - Standard Case	Left	Rear	n/a	Iron Head/Cover

## WABCO



9111535100X



9111535200X



9111535300X



9111535400X



9111535410X

Service Part No.	Model	Description	Bore Size	Water Port*	Discharge Port*	Governor Port*
9111535100X	SS318	CUMMINS ISX	85MM	M18 - 1.5 STOR	M27 - 2.0 STOR	M10 - 1.0 STOR
9111535200X	SS318	CUMMINS L, M, N	85MM	3/4" - 16 STOR	M27 - 2.0 STOR	M10 - 1.0 STOR
9111535300X	SS318	CUMMINS ISC, Thru Drive	85MM	3/4" - 16 STOR	M27 - 2.0 STOR	M10 - 1.0 STOR
9111535400X	SS318	Extended Flange with Gear, Thru Drive	85MM	3/8" NPT	1/2" NPT	1/8" - 27 NPT
9111535410X	SS318	Extended Flange with Gear, Non-Thru Drive	85MM	3/8" NPT	1/2" NPT	1/8" - 27 NPT

\* STOR - Straight Thread O-Ring

# Compressor Kits / Air Governor

## MANIFOLD KIT (INTAKE)

- Hose - 3/4"
- Mounting centers - 2.75

Service Part No.  
SN3711AD



## DISCHARGE HOSE ASSEMBLY (FLEXIBLE)

- 1/2" I.D.
- Ferrule and nut included
- For easy changeover from a Bendix® side mount discharge to a top discharge Haldex Compressor



Service Part No.	Description
KN17500	18"
KN17501	24"
KN17503	48"
KN17504	60"

## COMPRESSOR INSTALLATION KIT

- For EL1300/EL1600 Compressors

Service Part No.  
SN144

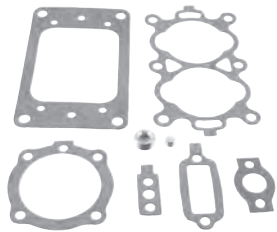

## INLET CHECK VALVE

- For EL1300/EL1600 Compressors

Service Part No.  
SN3711AJ



## MANIFOLD KIT (DISCHARGE)

- For all EL1300/EL1600 Compressors

Service Part No.  
SN3711AH - Side Outlet  
SN3711J - Threaded  
SN3711K - Right Hand  
SN3711L - Left Hand



SN3711J



SN3711K



SN3711L

## PISTON TYPE GOVERNOR

- Direct compressor or remote mount
- 1/8-27 NPT ports
- .336 Diameter mounting holes
- Cut-in Pressure of 105 PSI normal
- Cut-out Pressure of 130 PSI normal

Service Part No.  
KN18530 (new)



## REMANUFACTURED D-2 STYLE GOVERNOR

- Standard unit
- 1/8" ports
- Cut-in Pressure of 105-110 PSI normal
- Cut-out Pressure of 15-30 PSI above Cut-in

Service Part No.  
275491RX (CoreFree)



# Air Cleaners

- Large capacity
- Provides greater atmospheric air intake capacity
- Suitable for mounting on Haldex and competitive model compressors



Service Part No.	Description
100696E	Filter Only
KN19040	Assembly with Filter

Most Haldex Valves are available in New, Remanufactured and CoreFree.  
Please consult the Haldex Master Catalog (haldex.com) for our complete listing. +

## Relay Valves

- Used to apply and release service brakes on tractor or trailer
- Cover may be rotated without affecting performance or warranty
- Valves are supplied with and without brackets (brackets may be purchased separately)

### RG2 - TWO PORT TRAILER VALVE

- Compact size
- Control Position is in relationship to Delivery ports
- Mounting .34" on 1 1/2" centers
- Crack Pressure 5.6 +/- 1.0 PSI



Service Part No.	Supply	Delivery	Control Position
KN28500	(2) 3/8"	(2) 3/8"	90°
KN28510	3/8" & 1/2"	(2) 3/8"	90°
KN28514X*	1/2" & 3/8"	(2) 3/8"	90°
KN28520	(2) 1/2"	(2) 1/2"	90°
KN28531	1/2" & 3/8"	(2) 3/8"	0°

\* Available Remanufactured or CoreFree Only.

### RG5 - TWO PORT TRAILER VALVE

- Used on 2 tank, 3 valve trailer systems and tractor applications
- Made of durable EGC (Engineering Grade Composite)
- Crack Pressure 6.0 PSI



Service Part No.	Supply A	Supply B	Delivery	Control
KN28550	1/2" x 3/8" Nipple	Plugged	(2) 3/8"	1/4"
KN28551	Plugged	3/8"	(2) 3/8"	1/4"

### TWO PORT FAST AIR AND BALANCING (FAB)

- Speedup or fast air relay
- Used on converter dollies, long wheel base and towing trailers to accelerate Control signal and meet FMVSS121 Pressure differential requirements
- Cover may be rotated without affecting performance or warranty



Service Part No.	Supply	Delivery	Control	Crack Pressure
KN28300	(2) 1/2"	(2) 1/2"	3/8"	0 PSI

### TWO AND FOUR PORT SINGLE CONTROL LINE

- Used to apply and release service brakes on tractor or trailer
- Crack Pressure 4.6 PSI



KN28131

Service Part No.	Supply	Delivery	Control	Ports
KN28042	(2) 1/2"	(4) 1/2"	1/4"	4
KN28131	(2) 1/2"	(2) 1/2"	1/4"	2
KN28140	(2) 1/2"	(2) 1/2"	1/4"	2

### TWO AND FOUR PORT WITH ANTI-COMPOUNDING

- Built-in anti-compounding two-way check valve for spring brake Control
- Crack Pressure 4.6 PSI



KN28041

Service Part No.	Supply	Delivery	Control	Ports
KN28041	(2) 1/2"	(4) 1/2"	(2) 1/4"	4
KN28043	(2) 1/2"	(2) 1/2"	3/8" & 1/4"	2
KN28071	(2) 1/2"	(2) 1/2"	1/4" & 1/8"	2

### TWO PORT WITH INTEGRAL BRACKET

- Used to apply and release service brakes on tractor or trailer



KN28060

Service Part No.	Supply	Delivery	Control	Crack Pressure
KN28060	(2) 1/2"	(2) 3/8"	3/8"	4.6 PSI
KN28061	(2) 1/2"	(2) 1/2"	3/8"	4.6 PSI
KN28132	(2) 1/2"	(2) 1/2"	3/8"	7.0 PSI

### FOUR PORT WITH INTEGRAL BRACKET

- Used to apply and release service brakes on tractor or trailer



Service Part No.	Supply	Delivery	Control	Crack Pressure
KN28080	(2) 1/2"	(4) 3/8"	3/8"	7.0 PSI
KN28085	(2) 1/2"	(4) 3/8"	3/8"	4.6 PSI

## Relay Valves (cont'd)

### RELAY VALVE - FOUR (VERTICAL) PORTS - SINGLE CONTROL

- For tractor or trailer application
- Four Delivery ports facing down
- Low differential - high capacity
- Available in Remanufactured
- 3.0 PSI Crack Pressure



Service Part No.	Supply A	Supply B	Delivery	Control
A103600	3/4"	Plugged	(4) 3/8"	1/4"
A86472*	3/4"	Not Drilled-No Threads	(4) 1/2"	1/4"
A86473	1/2"	Not Drilled-No Threads	(4) 1/2"	1/4"
A86477	3/4"	Plugged	(4) 1/2"	1/4"

\* Available New Only.

## Isolation Valve

- Used in conjunction with a turbo-charged air compressor
- Added fuel economy and greater engine efficiency



Service Part No.  
KN23500

## Trailer Valves

### FF2 - FULL FUNCTION VALVE

- Single valve trailer system combines a Pressure protection valve, two one-way check valves, spring brake valve with quick release and a four port relay valve
- Easy to install, maintain and troubleshoot
- Meets FMVSS-121 anti-compounding requirements
- Available in Remanufactured and CoreFree



Service Part No.	Crack Press.	Res.	Control	Supply	Spring Brake	Delivery
KN28600	3.0	3/4"	1/4"	3/8"	(2) 3/8"	(4) 3/8"
KN28601	3.0	1/2"	1/4"	3/8"	(2) 3/8"	(4) 3/8"
KN28602*	5.0	3/4"	1/4"	3/8"	(2) 3/8"	(4) 3/8"
KN28603*	5.0	1/2"	1/4"	3/8"	(2) 3/8"	(4) 3/8"

### TRAILER BRAKE CONTROL VALVE

- Made of Engineering Grade Composite (EGC)
- Light weight; withstands high impact
- Integral anti-compounding
- Black Cover - Service Brake
- White Cover - Spring Brake



Service Part No.	Res.	Supply	Control	Delivery	Priority
KN26110	1/2"	3/8"	3/8"	(4) 3/8"	Service Brake
KN26120	1/2"	3/8"	3/8"	(4) 3/8"	Spring Brake
KN26121	1/2"	3/8"	3/8"	(4) 3/8"	Service Brake

### EMERGENCY RELAY VALVES

- Pre-121 trailers, converter dollies or exempt trailers
- Crack Pressure: New - 3.0 PSI  
Reman/CoreFree - 4.5 PSI
- KN30100 - auto. bleed down feature
- KN30200 - non-charging
- KN30300 and KN30400 - charging



Service Part No.	Svc. Inlet	Emerg. Inlet	Delivery	Aux. Reservoir	Reservoir
KN30100	1/4"	1/4"	(4) 1/4"	Plugged	3/4"
KN30200	3/8"	3/8"	(4) 3/8"	1/2"	Plugged
KN30300	1/4"	1/4"	(4) 1/4"	Plugged	3/4" w/Nipple
KN30400	1/4"	1/4"	(4) 3/8"	Plugged	3/4" Female w/Nipple

### RT-4 MULTI-FUNCTION TRAILER VALVES

- Used on trailers to Control both parking and emergency brake functions
- KN26000X - Closing PPV 55 PSI
- KN26010/KN26020 - Closing PPV 70 PSI
- Meets FMVSS-121 trailer requirements



Service Part No.	Trailer Supply	Trailer Control	Reservoir	Delivery
KN26000X*	(2) 3/8"	1/4"	3/8"	(4) 3/8"
KN26010	3/8" & Plugged	3/8"	1/2" & 3/8"	(4) 3/8"
KN26020	(2) 3/8"	3/8"	1/2" & 3/8"	(4) 3/8"

\* Available Remanufactured or CoreFree Only.



Most Haldex Valves are available in New, Remanufactured and CoreFree.  
Please consult the Haldex Master Catalog (haldex.com) for our complete listing. +

## Hand Operated Valves

### MANIFOLD DASH VALVE

- Replacement for the MV2/MV3 Valve
- One piece construction provides no center body leakage
- Made of durable Engineering Grade Composite (EGC)



Service Part No.	Description	Mount	Ports
KN20607	M6 Metric Nuts on Cover	Vertical	3/8" PTC
KN20611	1/4"-20 Well Nuts in Body	Horizontal	1/4"
KN20615	1/4" Hole in Body	Horizontal	1/4"
KN20616	1/4"-20 Well Nuts in Body	Vertical	1/4"
KN20619	1/4" Hole in Body	Vertical	3/8" PTC

### PUSH-PULL HOSTLER VALVE

- Panel or bulkhead mount
- Requires 3/4" hole in dashboard



Service Part No.	Ports	Pop Pressure	Knob
KN20010	1/4"	25/40 PSI	Plain Knob
KN20011	1/4"	0 PSI	Plain Knob
KN20015	1/4"	25/40 PSI	Trailer Emergency Knob

### PUSH-PULL PARKING BRAKE VALVE

- Replacement for the PP-1 Valve
- Bulkhead mount - 7/8"
- Made of durable Engineering Grade Composite (EGC)
- Pop Pressure-35+/-10 PSI
- Knob Included



Service Part No.	Description	Ports
KN20021	System Brake	1/8" NPT
KN20022	Parking Brake	1/8" NPT

### FLIPPER STYLE PANEL MOUNT

- Panel or remote mount
- Made of durable Engineering Grade Composite (EGC)
- An on-off, non-automatic 2-position valve
- Chrome Handle
- All Ports 1/8"



Service Part No.	Description
KN20001	#10-24 with 1.50" Center Mounting Holes
KN20002	M5 Metric with 1.50" Center Mount Holes

### PP-8 REPLACEMENT VALVE

- Replacement for the PP-8 Valve
- Controls tractor only parking
- Made of durable Engineering Grade Composite (EGC)
- Bulkhead mount - 7/8"
- All Ports 1/8"-27 NPT



Service Part No.  
KN20035

### PP-7 REPLACEMENT VALVE

- Replacement for the PP-7 Valve
- Controls Tractor Protection Valve
- Made of durable Engineering Grade Composite (EGC)
- Bulkhead mount - 7/8"



Service Part No.	Supply	Control	Delivery	Exhaust
KN20025	1/8" NPT	1/8" NPT	1/4" NPT	1/4" NPT

### PUSH-PULL PANEL MOUNT VALVE

- Panel mount
- All Ports are 1/4"
- Made of durable Engineering Grade Composite (EGC)



Service Part No.	Description
KN20031	Pop Pressure 25-35 PSI
KN20033	Pop Pressure 7-17 PSI

Most Haldex Valves are available in New, Remanufactured and CoreFree.  
Please consult the Haldex Master Catalog (haldex.com) for our complete listing. +

## Drain Valves

### AUTOMATIC DRAIN VALVE

- Expels moisture with each brake application
- Removes excess moisture and contamination from "wet" tank
- Performs independently from compressor cycling
- Direct replacement for Bendix® DV2
- Built in heater prevents valve freeze-ups
- Built in filter protects valve against contamination



Service Part No.	Description
KN24000	Not Heated
KN24001	Heated - 12V

Service Part No.	Description
41010019	Heated - 12V
41010021	Heated - 24V

### MANUAL DRAIN VALVE

- Manual wet or dry tank drain valves
- Cable is looped on both ends for easy hand hold
- All models have 1/4"-18 NPT threads
- Vibra-Seal applied to threads



HIGH PROFILE Service Part No.	LOW PROFILE Service Part No.	Description
12100	KN21100	No Cable
12103	KN21103	3' Cable
12104	KN21104	4' Cable
12105	KN21105	5' Cable

## Inversion Valve

- Used with spring brake equipped trucks
- Complies with FMVSS-121 regulations
- Detects primary Control line failure, allowing modulated Control of spring brake
- Interchangeable with competitive units without anti-compounding feature



KN28032

Service Part No.	Primary Res.	Supply	Control	Delivery	Version
KN28030	1/4"	1/4"	1/4"	1/4"	Pre-March 1998
KN28032	1/4"	1/4"	1/4"	1/4"	Post-March 1998
KN28034	3/8" PTC	3/8" PTC	3/8" PTC	3/8" PTC	Pre-March 1998

## Reservoir Purge Valve

- Automatically purges water and other contaminants from reservoirs when vehicle is placed into park
- Filter design protects valve from debris and is easy to service without removing valve from the vehicle
- Purge function is not dependent on compressor cycle
- Built-in mounting bracket (2X Ø.27" Bolt Holes)
- Filter Replacement Kit. **Service Part No. 48100200.**



Service Part No.	Supply	Control	Delivery
KN21200	(1) 3/8-18 NPTF	(4) 3/8-18 NPTF	(3) 3/8-18 NPTF

## Quick Release Valves

### QUICK RELEASE VALVE

- Made of durable Engineering Grade Composite (EGC)
- Lightweight



Service Part No.	Inlet	Outlet	Crack Pressure
KN32003	1/2"	3/8"	3 PSI
KN32005	3/8"	3/8"	0 PSI
KN32011	1/2"	3/8"	0 PSI
KN32013*	1/2"	3/8"	0 PSI
KN32060	3/8"	3/8"	6 PSI

\* Extra life QR Valve with dirt exclusion seal.

### QUICK RELEASE VALVE W/TWO-WAY CHECK

- Used in spring brake Control circuits to prevent compounding on trucks and tractors
- Replaces two valves with one



Service Part No.	Control	Delivery
KN32040	1/4"	1/4"
KN32041	1/4"	3/8"

Most Haldex Valves are available in New, Remanufactured and CoreFree.  
Please consult the Haldex Master Catalog (haldex.com) for our complete listing. +

## Pressure Relief Valve

- Non-adjustable
- Made of brass and stainless steel
- Factory set at 150 PSI

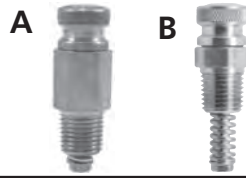

STYLE A AIRLINES Service Part No.	STYLE B RESERVOIRS Service Part No.	Thread Size
KN31400	KN31200	1/4"
KN31450	KN31250	3/8"
KN31300	-	1/2"

## Solenoid Valve

- Used to operate the shift mechanism of a two speed axle



Service Part No.	Description
KN68230	12V
KN68237	24V

## Tractor Protection Valves

### TRACTOR PROTECTION VALVE THREE LINE - AUTOMATIC

- Equipped with built-in quick release to improve trailer timing
- Eliminates the need for a separate valve
- Interchangeable with most competitive units



Service Part No.	Description
KN34050X	3-Line with Snorkel Exhaust
KN34070X	3-Line without Quick Release

Port orientations detailed in Haldex Master Catalog (haldex.com).

### TRACTOR PROTECTION VALVE MANIFOLD TYPE - NON-AUTOMATIC

- Includes tractor protection, two double check valves, stoplight switch port and built-in quick release

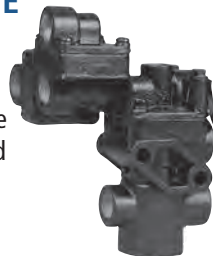

Service Part No.	Description
KN34110	2-Line; With Exhaust Tube
KN34111	2-Line; No Exhaust Tube

Port orientations detailed in Haldex Master Catalog (haldex.com).

### TRACTOR PROTECTION VALVE - TWO LINE NON-AUTOMATIC

- Must be used with Pressure Sensing Dash Control Valve
- Built-In Quick Release



Service Part No.	Tractor Service	Tractor Emergency	Trailer Service	Trailer Emergency
KN34060	3/8"	1/4"	1/2"	1/2"
KN34061*	3/8"	1/4"	1/2"	1/2"

\*Exhaust Fitting

Most Haldex Valves are available in New, Remanufactured and CoreFree.  
Please consult the Haldex Master Catalog (haldex.com) for our complete listing. +

## Pressure Protection Valves

### PRESSURE PROTECTION VALVE

- E-coated zinc diecast body provides exceptional corrosion resistance
- Premium Nitrile diaphragm provides long life and reliability
- Durable design increases product life, reducing replacement costs
- Use in air suspensions, air seats and cab isolation systems



90554107

90555397

Service Part No.	Port Sizes	Closing Pressure	Opening Pressure	Filter
90554107	1/4" NPT	70PSIG	75 PSIG Min.	Yes
90555396	1/4" NPT	65 PSI	70 PSI	No
90555397	1/4" NPT	80 PSI	85 PSI	No
90555398	1/4" NPT	90 PSI	95 PSI	No

### PRESSURE PROTECTION VALVE WITH ONE-WAY CHECK

- One-way check valve prevents reverse air flow
- Exceptional corrosion resistance



Service Part No.	Port Sizes	Closing Pressure	Opening Pressure
90555409	1/4" NPT	65 PSI	70 PSI
90555410	1/4" NPT	80 PSI	85 PSI
90555411	1/4" NPT	90 PSI	95 PSI

## Check Valves

### ONE-WAY CHECK VALVE

- Positive, long lasting valve for every application on trucks, tractors and trailers



Service Part No.	Port Sizes
KN23000	1/2"
KN23010	3/8"
KN23040	3/4"
KN23060	1/2" 90° Brass

### TWO-WAY CHECK VALVE

- Shuttle type valve, mounts horizontally.
- Interchangeable with most competitive models



Service Part No.	Inlet	Inlet	Outlet	Outlet
KN28050	3/8" Male with Nipple	3/8" Female	3/8" Female	1/4" Female Reducer
KN25090	3/8" Female	3/8" Female	3/8" Female	1/4" Female Reducer

## Foot Operated Valve

### SINGLE CIRCUIT FOOT VALVE

- Used primarily with Pre FMVSS-121 vehicles
- Provides smooth and consistent pedal feel
- Interchangeable with most competitive units



Service Part No.	Delivery	Supply
KN22100	(4) 1/2"	(2) 1/2" / (2) 1/4"

# Remanufactured Competitive Valves +

## Bendix® R-12 RELAY VALVE



Service Part No.	Supply	Delivery	Control	Exhaust	Crack Pressure
102626X	1/2"	(4) 1/2"	1/4"	-	4 PSI

## Bendix® PP-1 HAND CONTROL VALVE



Service Part No.	Supply	Delivery	Control	Exhaust	Crack Pressure
276567X	1/8"	1/8"	-	1/8"	-

## Bendix® E-6 DUAL CIRCUIT FOOT VALVE



Service Part No.	Supply	Delivery	Control	Exhaust	Crack Pressure
286171X	(4) 3/8"	(4) 3/8"	-	-	-

## Bendix® RE-6 EMERGENCY RELAY VALVE



Service Part No.	Supply	Delivery	Svc. Emerg.	Emerg.	Initial Emerg. Applic. Press.	Max. Emerg. Release Press.
281865X	(1) 3/8" (1) 3/4"	(2) 1/4" (2) 3/8"	1/4"	1/4"	50±5 PSI	95 PSI

## Bendix® QR-1 QUICK RELEASE VALVE



Service Part No.	Supply	Delivery	Exhaust	Crack Pressure
229859X	3/8"	3/8"	-	1 PSI

## SEALCO RATIO RELAY TRAILER VALVES



110500X

110170X



Service Part No.	Supply	Delivery	Reservoir A	Reservoir B	Control
110170X	3/8"	(4) 3/8"	1/2"	1/2"	3/8"
110500X	3/8"	(4) 3/8"	1/2"	3/8"	3/8"

## Bendix® MV-3 (MANIFOLD) HAND CONTROL VALVE



Service Part No.	Reservoirs	Tractor Delivery	Trailer Delivery	Exhaust
800516RX	(2) 1/4"	1/4"	1/4"	1/4"

## Controlled Response (CR) Height Control Valve

- Controlled response time delay technology maintains chassis Position and conserves air to increase compressor life
- Robust diecast zinc body to ensure operation in extreme conditions
- Flexible right or left mounting options provide ease of installation and reduced inventories
- Optional integrated dump valve provides the ability to automatically or manually exhaust air from the suspension
- All Ports are 1/8" NPT

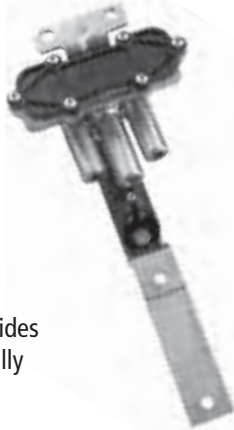

Service Part No.	Dump Valve	Fittings
90054007	n/a	1/4"
90554114	n/a	No Fittings
90554147	n/a	Adapt 1/8" NPT to M10 x 1
90554183	n/a	3/8"
90554334	Normally Open	1/4" and 3/8"
90554648	Normally Closed	1/4" and 3/8"

## Precision Response (PR) and PR Plus HCV

- Use of ceramic seal technology allows the valve to be very reliable and highly durable even in the most extreme conditions
- Non-time delay valve
- Tight dead zone
- Provides precise adjustment to ride height variation
- Normally Open Dump Valve



Service Part No.	Arm	Manifold Port	Pilot Port	All Other Ports
90555318	7" Fixed	3-Port Side	1/4" PTC	3/8" PTC
90555353	7" Fixed	5-Port Side	1/4" PTC	3/8" PTC
90555375	7" Adjustable	3-Port Side	1/4" PTC	3/8" PTC
90555376	7" Adjustable	2-Port Straight	1/4" PTC	3/8" PTC
90555377	7" Adjustable	3-Port Straight	1/4" PTC	3/8" PTC
90555382	7" Adjustable	3-Port Straight	1/4" PTC	3/8" PTC

## Suspension Dump Valves

Service Part No.	Dump Valve	Body Color
90554335	Optional Normally Open	Gold
90554902	Optional Normally Closed	Silver



For CR Type HCV

## COLAS Raise/Lower Hand Valve

- Manual raise/lower hand valve for commercial vehicles and trailers
- Works with single or dual height Control valve systems
- Horizontal or vertical installation with external mounting
- Optional automatic return to ride height makes valve error proof
- One component and fewer fittings reduces installation time
- Available with Push-To-Connect (PTC) fittings

Service Part No.	Fittings
90555270	3/8" Push-To-Connect (PTC)
90555292	1/4" Push-To-Connect (PTC)



## Suspension EGP HCV

- Dual or single circuit operation without extra ports or fittings
- High grade durable all plastic construction for corrosion protection
- Optional dump valve available
- 1/4" NPT fittings

Service Part No.	Description
KN27000	Standard Flow with 14" Lever Arm
KN27013	High Flow with 14" Lever Arm
KN27201	Low Flow (Valve Only)
90555105	Standard Flow (IR Type Valve Only)
90555106	Standard Flow with Normally Open IR Type Dump Valve
42150003	Standard Flow with Dual Ride Height IR Type Valve, Vertical Arm 20", Horizontal Arm 12"



## ILAS III Integrated Lift-Axle System Valve

- Integrated lift axle system: responds to Pressure in air suspension and automatically lowers the lift axle when loaded. Error proof valve lowers lift axle when unit is loaded
- Manual version: lift axle is manually raised by pushing button in
- Automatic version: automatically lifts axle when load is removed
- Single component reduces assembly time and alleviates complicated plumbing issues
- Solid structure allows for easy external mounting
- Push-To-Connect (PTC) fittings should not be used in Canada due to extreme cold

Service Part No.	Description	Ports
90555425	ILAS III Manual	1/4" - 18 NPT Threaded
90555426	ILAS III Automatic	1/4" - 18 NPT Threaded



90555425



90555426

## ILAS E Integrated Lift-Axle System Valve

- Offers a cost effective installation for electronically controlled lift axles
- Simplified solutions reduce components and fittings
- Higher air flow provides faster response time of the lift axle
- Push-To-Connect (PTC) fittings
- Use with Haldex Trailer Roll Stability (TRS) or with manual electric switch
- DIN-Bayonet electrical connection
- Programmable through Haldex Trailer Roll Stability (TRS) for raising and lowering lift axle

Service Part No.	Description
62101005	ILAS E Lift Axle Valve Kit
90555326	ILAS E Valve
814012131	ILAS E Power Cable



# Scale-O-Matic

Service Part No.	Description
42123026	Enclosed Manual Switch, Pilot Valve and Silicone Filled Gauge
42123039	Silicone Filled Gauge with Calibration Decal
90554346	Large Weather Proof Enclosure Box
90554628	Small Weather Proof Enclosure Box



Consult the Haldex Master Catalog ([haldex.com](http://haldex.com)) for a complete listing of Scale-O-Matic Products.

## Linkage

- Fixed Rod Linkage must be ordered at the correct length Available in .025" increments from 4.5" to 19 5/8". To order a 14.25" linkage, specify the model number FB14.25-I, for a 16" linkage the model number would be FB16-I.
- Fixed Loop Linkage must be ordered at the correct length. Available in .025" increments from 4.5" to 19 5/8". To order a 10.5" linkage, specify the model number LP10.5-I, for a 12" linkage the model number would be LP12-I.

Service Part No.	Description
48100225	Adjustable Linkage Model SRK 168 19 5/8" Maximum

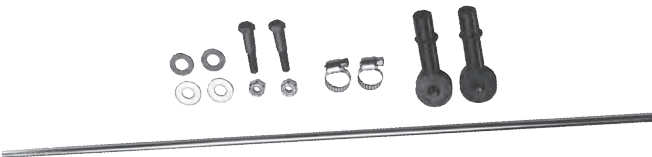

Consult the Haldex Master Catalog ([haldex.com](http://haldex.com)) for a complete listing of Linkage Products.

## Manually Operated Valve

- Small, Self-Relieving Manual Switch
- All Ports 1/8" NPT



Service Part No.  
90054088

## Pilot Valve

- Activated by applying pilot pressure
- Remote mounted valve suited for any chassis location
- Typically used on auxiliary axle applications or to rapidly exhaust air suspensions

Service Part No.	Port A	Port B
90054088	1/4" NPT	1/8" NPT

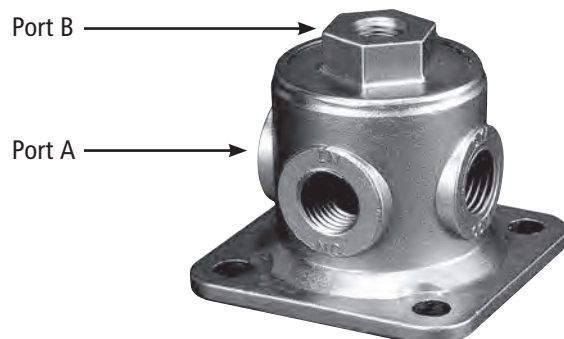



# Double Diaphragm Spring Brakes - GoldSeal

## GoldSeal

### GoldSeal Features and Benefits:

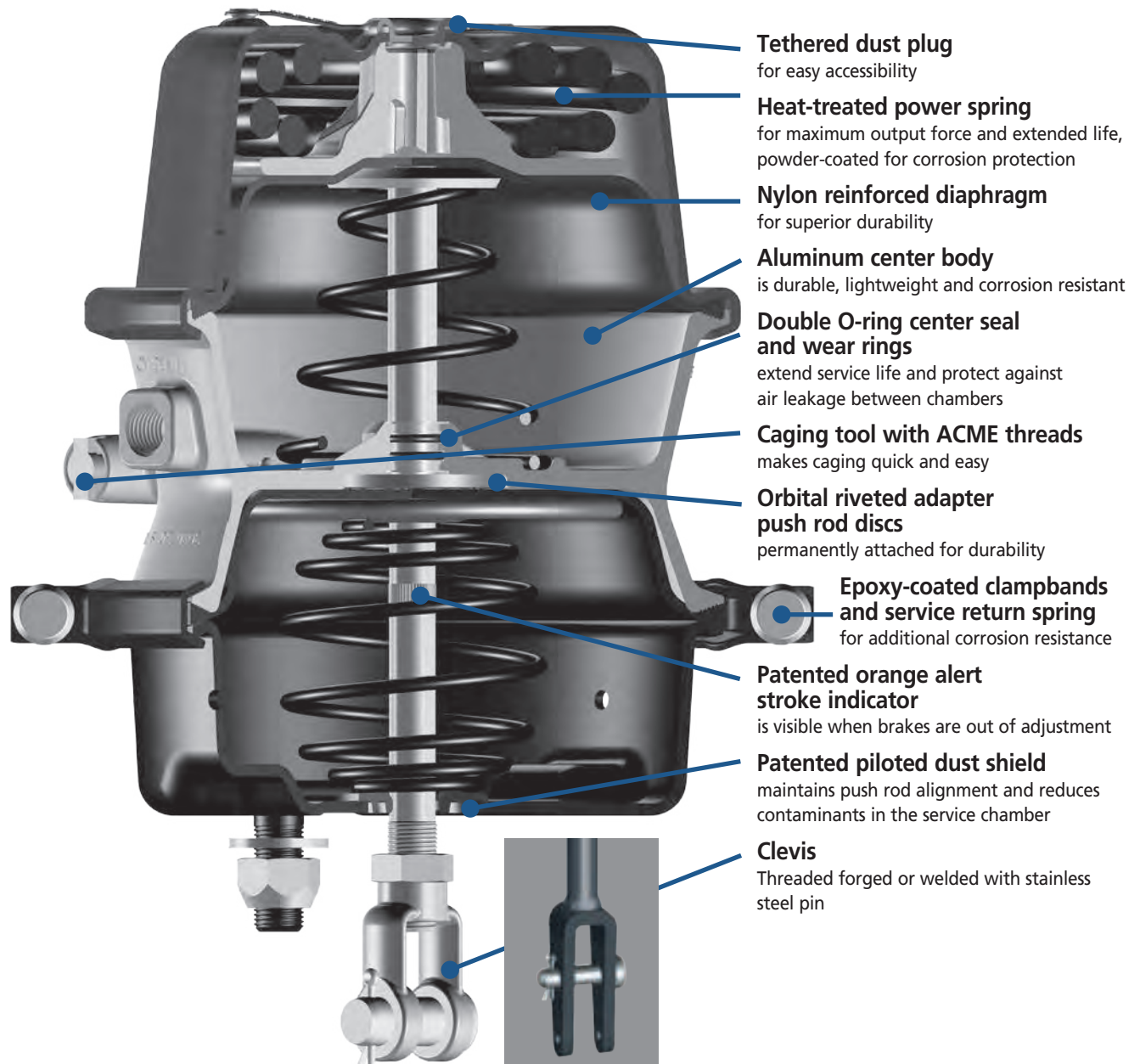

# Double Diaphragm Spring Brakes - GoldSeal

## GoldSeal™ Standard 4-Year Warranty

Spring Brake size and stroke	Service Part No.	Clevis	Pushrod length from face of service housing	Distance to Clevis Pin centerline from face of service housing	Housing	Power Spring
1624 2.25"	GP1624			Piggyback		Standard
2024 2.25"	GP2024			Piggyback		Standard
	GC2024	Threaded	10.00"	n/a	Standard	Standard
2030 3.0"	GC2030XL	Threaded	10.00"	n/a	Standard	Standard
	GC2030XLCW	Welded	n/a	2.25"	Standard	Standard
2424 2.25"	GP2424			Piggyback		Standard
	GC2424	Threaded	9.65"	n/a	Standard	Standard
2424 2.5"	GP2424L			Piggyback		Standard
	GC2424L	Threaded	10.00"	n/a	Standard	Standard
2430 2.5"	GP2430L			Piggyback		Standard
	GC2430L	Threaded	10.00"	n/a	Standard	Standard
2430 3.0"	GP2430XL			Piggyback		Standard
	GC2430XL	Threaded	10.00"	n/a	Standard	Standard
	GC2430XLCW	Welded	n/a	2.25"	Standard	Standard
3030 2.5"	GP3030			Piggyback		Standard
	GP3030K			Piggyback w/bolted clampband and diaphragm		Standard
	GC3030	Threaded	10.00"	n/a	Standard	Standard
	GC3030HD	Threaded	10.00"	n/a	Heavy Duty	Standard
	GC3030R	Threaded	14.00"	n/a	Standard	Standard
	GC3030S1	Threaded	1.80"	n/a	Standard	Standard
	GC3030S2	Threaded	5.70"	n/a	Standard	Standard
	GC3030S3	Threaded	1.80"	n/a	Standard	Standard
	GC3030S4	No	9.90"	n/a	Standard	Standard
	GC3030S5	No	5.90"	n/a	Standard	Standard
	GC3030Q*	No	16.80"	n/a	Standard	Standard
	GC3030S7CW	Welded	n/a	4.20"	Standard	Standard
	GC3030CW	Welded	n/a	2.25"	Heavy Duty	Standard
	GC3030S4CW	Welded	n/a	11.00"	Heavy Duty	Standard
	GC3030S5CW	Welded	n/a	6.80"	Heavy Duty	Standard
	GC3030S6CW	Welded	n/a	2.87"	Heavy Duty	High Output
3030 3.0"	GP3030L			Piggyback		Standard
	GP3030LHO			Piggyback		High Output
	GP3030LK			Piggyback w/bolted clampband and diaphragm		Standard
	GC3030L	Threaded	10.00"	n/a	Standard	Standard
	GC3030LR	Threaded	14.00"	n/a	Standard	Standard
	GC3030LS4	No	9.90"	n/a	Standard	Standard
	GC3030LHD	Threaded	10.00"	n/a	Heavy Duty	High Output
	GC3030LQ*	No	16.80"	n/a	Heavy Duty	Standard
	GC3030LCW	Welded	n/a	2.25"	Heavy Duty	Standard
	GC3030LS4CW	Welded	n/a	11.00"	Heavy Duty	Standard
	GC3030LS5CW	Welded	n/a	6.80"	Heavy Duty	Standard
	GC3030LS6CW	Welded	n/a	2.87"	Standard	High Output
	GC3030LS7CW	Welded	n/a	4.20"	Standard	Standard
3036 2.5"	GC3036	Threaded	10.00"	n/a	Heavy Duty	Standard
	GC3036CW	Welded	n/a	2.25"	Heavy Duty	Standard
	GC3036Q*	No	16.80"	n/a	Heavy Duty	Standard
3036 3.0"	GC3036L	Threaded	10.00"	n/a	Heavy Duty	Standard
	GC3036LCW	Welded	n/a	2.25"	Heavy Duty	Standard
3636 2.5"	GP3636			Piggyback		Standard
3636 3.0"	GP3636L			Piggyback		Standard
3636 3.0"	GC3636	Threaded	9.00"	n/a	Heavy Duty	Standard
	GC3636CW	Welded	n/a	2.25"	Heavy Duty	Standard
	GC3636Q*	No	9.00"	n/a	Heavy Duty	Standard
Disc Brake Offerings	GC1824D	GC2024D	GC2030D	GC2430D		

\*3/4 Pushrod Thread (standard 5/8)

# Double Diaphragm Spring Brakes - LifeSeal+

**LifeSeal+**<sup>™</sup>

New **LifeSeal+** Features and Benefits:

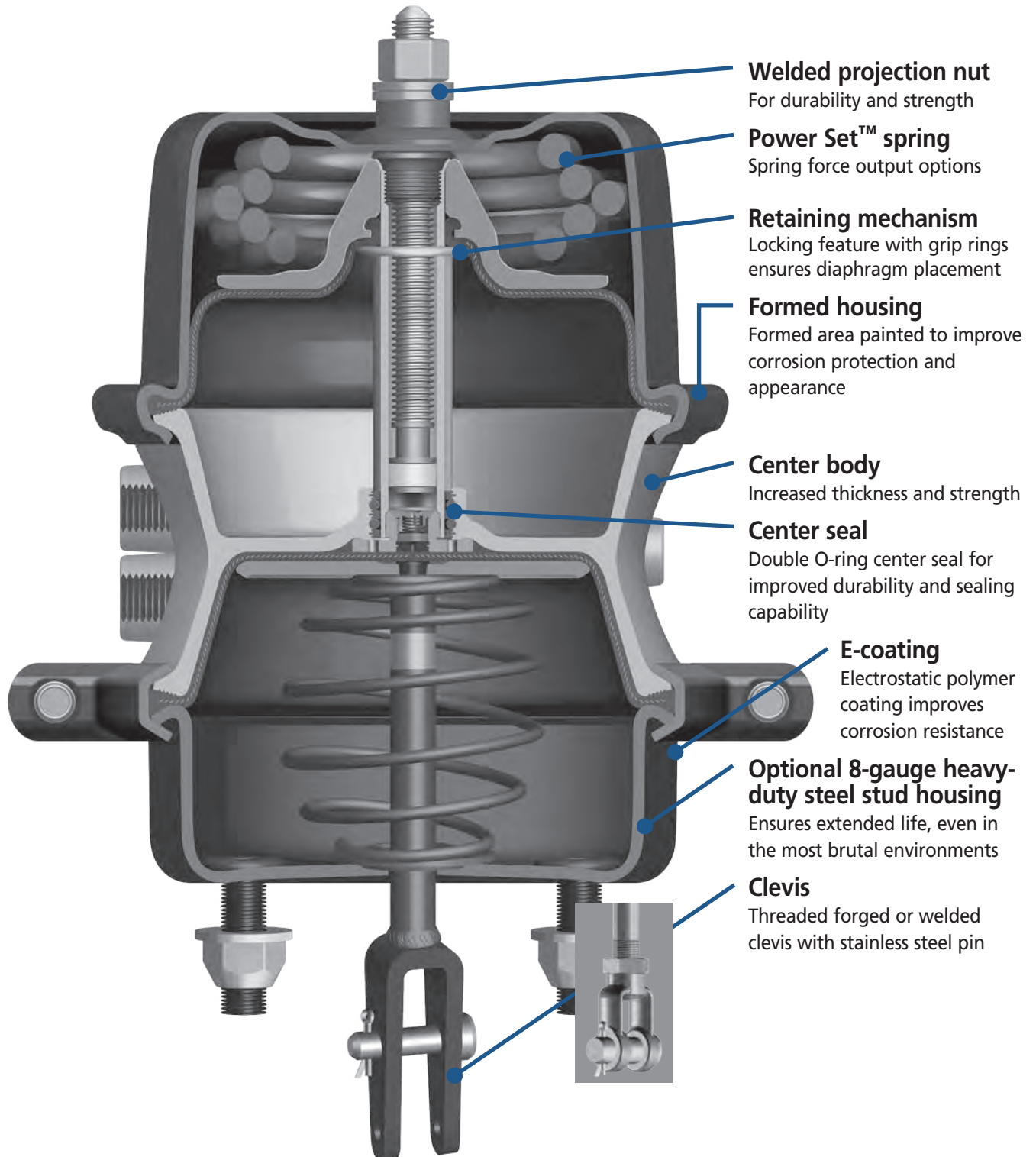

# Double Diaphragm Spring Brakes - LifeSeal+

## LifeSeal+™ Standard 8-Year Warranty

Spring Brake size and stroke	Service Part No.	Clevis	Pushrod length from face of service housing	Distance to Clevis Pin centerline from face of service housing	Housing	Power Spring
2430 2.5"	LPP2430			Piggyback		Standard
	LCP2430	Threaded	10.00"	n/a	Standard	Standard
	LCP2430CW	Welded	n/a	2.25"	Standard	High Output
2430 3.0"	LPP2430L			Piggyback		Standard
	LCP2430L	Threaded	10.00"	n/a	Heavy Duty	Standard
	LCP2430LCW	Welded	n/a	2.25"	Heavy Duty	High Output
3030 2.5"	LPP3030			Piggyback		High Output
	LPP3030K			Piggyback with bolted clampband and diaphragm		Standard
	LCP3030S1	No	4.40"	n/a	Heavy Duty	High Output
	LCP3030S4	No	9.90"	n/a	Standard	Standard
	LCP3030	Threaded	10.00"	n/a	Heavy Duty	Standard
	LCP3030HD	Threaded	10.00"	n/a	Heavy Duty	High Output
	LCP3030R	No	14.00"	n/a	Heavy Duty	Standard
	LCP3030Q*	No	16.80"	n/a	Standard	High Output
	LCP3030CW	Welded	n/a	2.25"	Heavy Duty	High Output
	LCP3030S6CW	Welded	n/a	2.87"	Heavy Duty	High Output
	LCP3030S7CW	Welded	n/a	4.20"	Standard	High Output
	LCP3030S5CW	Welded	n/a	6.80"	Heavy Duty	Standard
	LCP3030S4CW	Welded	n/a	11.00"	Heavy Duty	Standard
	3030 3.0"	LPP3030L			Piggyback	
LCP3030LS4		No	9.90"	n/a	Heavy Duty	Standard
LCP3030L		Threaded	10.00"	n/a	Heavy Duty	Standard
LCP3030LHD		Threaded	10.00"	n/a	Heavy Duty	High Output
LCP3030LR		No	14.00"	n/a	Heavy Duty	Standard
LCP3030LQ*		No	16.80"	n/a	Heavy Duty	High Output
LCP3030LCW		Welded	n/a	2.25"	Heavy Duty	High Output
LCP3030LS6CW		Welded	n/a	2.87"	Heavy Duty	High Output
LCP3030LS7CW		Welded	n/a	4.20"	Heavy Duty	High Output
LCP3030LS5CW		Welded	n/a	6.80"	Heavy Duty	Standard
LCP3030LS4CW		Welded	n/a	11.00"	Heavy Duty	Standard
LPP3030LK				Piggyback with bolted clampband and diaphragm		Standard

\*3/4 Pushrod Thread (standard 5/8)

For separate clevis purchase, see part numbers CF2 and CF4

# Double Diaphragm Spring Brakes - Replacement Parts

## Replacement diaphragm

Service Part No.	Description
DP20	T20 - 2.25"
DP20L	T20 - 2.50" - long
DP24L	T24 - 2.25" & T24 - 2.50" - long
DP24XL	T24 - 3.00" - extra long
DP30	T30 - 2.50" - standard
DP30L	T30 - 3.00" - long
DP36	T36 - 3.00" - standard

Available in 10-packs

## Replacement clampband assembly kit

Service Part No.	Description
CB20	T20
CB20S1	T20 - service chamber
CB24	T24
CB24S1	T24 - service chamber
CB30	T30
CB30S1	T30 - service chamber
CB36S1	T36 - service chamber

Available in 10-packs

## Replacement clevis

Service Part No.	Description
CP1	Clevis pin - 1/2"
CP1S	Clevis pin - 1/2" - stainless steel
CP3	Clevis pin - 14mm pin, 41mm length
CF1	Clevis forged - 1/2" pin - 1/2" - 20 UNF
CF2	Clevis forged - 1/2" pin - 5/8" - 18 UNF
CF3	Clevis forged - 5/8" pin - 5/8" - 18 UNF
CF4	Clevis forged - 1/2" pin - 3/4" - 16 UNF
CF5	Clevis forged - 14mm pin - M16 x 1.5
CF10	Clevis forged - 1/2" - stainless steel pin, 5/8"-18 UNF

Available in 10-packs

## Replacement hardware

Service Part No.	Description
HW2	Mounting kit - lock washer & standard nut - 5/8" - 11
HW3	Mounting kit - flat washer & standard nut - 5/8" - 11
HW5	Jam nut - 5/8" - 18 UNF
HW6	Jam nut - M16
HW8	Clampband nut & bolt - 3/8" - 24
HW10	90° elbow - 3/8" - 18 NPT

Available in 10-packs

## Service chambers

Service Part No.	Description
SC09	T09 - 1.75" - standard
SC12	T12 - 1.75" - standard
SC16	T16 - 2.25" - standard
SC16L	T16 - 2.50" - long
SC20	T20 - 2.25" - standard
SC20L	T20 - 2.50" - long
SC20LCW	T20 - 2.50" - long - welded clevis
SC24	T24 - 2.25" - standard
SC24L	T24 - 2.50" - long
SC24XL	T24 - 3.00" - extra long
SC24XLCW	T24 - 3.00" - extra long - welded clevis
SC30	T30 - 2.50" - standard
SC30CW	T30 - 2.50" - standard - welded clevis
SC30L	T30 - 3.00" - long - 3.00"
SC30LCW	T30 - 3.00" - long - welded clevis
SC36	T36 - 3.00" - standard

## Replacement miscellaneous

Service Part No.	Description
BA1*	Boot assembly - 5/8" push rod
DS1*	Dust shield - 5/8" push rod - 1" (25.4mm) hole
DS2*	Dust shield - 3/4" push rod - 1" (25.4mm) hole
DS3*	Dust shield - 5/8" push rod - 1.58" (40mm) hole
DS4*	Dust shield - 3/4" push rod - 1.58" (40mm) hole
PH30	T30 pressure housing - 2.50" / 64 mm, 3/8"- NPTF air inlet
PP1*	Pipe plug fitting - 3/8" - square head
PR30	T30 service push rod - 5/8" - 18 UNF
PR30S1	T30 service push rod - 3/4" - 16 UNF
RS5	Return spring - 2.5" Midland® & T30 & 3030 models
RS6	Return spring - Anchorlok® and Haldex except 3636 and RS5
RS7	Return spring - GoldSeal™ 3636
RT1*	Release tool - all DDSB† except 3036 and 3636
RT2*	Release tool - 3036 and 3636
RT3*	Release tool - remote chamber
RTP1*	Release tool plug - all DDSB† except 3036 and 3636
RTP2*	Release tool plug - old Midland style
RTP3*	Release tool plug - 3036 and 3636

\* Available in 10-packs

† DDSB = Double diaphragm spring brakes

## Midland Actuator

- Proven reliability and extended life
- Spring chamber is permanently attached / sealed
- Oil, chemical and water resistant diaphragms for maximum life
- High grade steel mounting studs provide maximum mounting strength
- Clevis assembly included
- Double bolted service clampband for adjustment and secure, positive attachment
- Fully immersed black polymer coated spring and stud housing for corrosion protection
- One Year, Unlimited Mileage Warranty (does not include vocational/transit applications)
- 3030 DDSB Models available in 2.5" and 3.0" stroke, 10.0" Pushrod



Sold in pallet quantities only.

Service Part No.	Description
MID3030P76	2.5" Stroke - Pallet Quantity 76
MID3030LP60	3.0" Stroke - Pallet Quantity 60

## Maxibrake Spring Brake

- Complete spring brake
- All steel construction
- Rugged/Corrosion resistant design



Service Part No.	Description	Avail. Stroke
MA15775	2475 Universal Spring Brake	2.25"
MA15777	3075 Universal Spring Brake	2.62"
MA15779	3765 Universal Spring Brake	3.00"

## Maxibrake "H" Series

- For Durapark system spring brake only
- All steel construction
- Rugged/Corrosion resistant design



Service Part No.	Description	Avail. Stroke
MA15500	Hydraulic Spring-Set Brake	2.00"
MA15500X	Hydraulic Spring-Set Brake - Reman	2.00"
MA15502	Hydraulic with Elbow Fitting	2.00"
MA15502X	Hydraulic with Elbow Fitting - Reman	2.00"
MA15514	Air Spring	2.00"

# 7-Way Plugs & Receptacles

## HEAVY DUTY DIECAST PLUGS

- Durable zinc, diecast housing for rugged service
- Meets requirements of SAE J560
- Brass terminal pins for maximum current carrying ability
- Fully interchangeable with other SAE Type, 7-way plugs



Service Part No.	Description
B202610	Replacement Insert
B205140	Spring Guard Only
BE23783	Trailer Plug Assembly Only
BE23784	Trailer Plug Assembly with Spring Guard

## HEAVY DUTY DIE CAST RECEPTACLE

- Durable zinc, diecast housing for rugged service
- Meets requirements of SAE J560
- Brass terminal pins for maximum current carrying ability
- Fully interchangeable with other SAE Type, 7-way receptacles
- Wire insertion style



Service Part No.	Description
B202611	Replacement Insert
B205010	Receptacle Boot
BE16797	Metal Door Lid Kit
BE23703	Receptacle Assembly - Split Pin

## HEAVY DUTY POLY PLUG & RECEPTACLE



Service Part No.	Description
BE16730	Plug Assembly with Spring Guard
BE23707	Receptacle Assembly - Ring Terminal
BE23709	Receptacle Assembly - Bullet Terminal
BE23717	Receptacle Assembly - Wire Insert Style

## DIE CAST AUXILIARY FOR SECONDARY CABLES

- Meets auxiliary requirements of SAE J560 (replaces ISO 3731)
- For use with secondary cable for auxiliary requirements
- Male ground pin on plug and female ground pin on receptacle prevent mixed connections



Service Part No.	Description
B205010	Receptacle Boot
BE23712	Auxiliary Receptacle with Diecast Housing
BE23790	Auxiliary Receptacle with Diecast Housing and Spring Guard

## TWO POLE PLUG & RECEPTACLE TAILGATE CONNECTORS

- One Positive - One Negative Pole
- 200 AMP Capacity
- Terminals Accept 4 Gauge Cable
- Receptacle Lug - Stud Hole Size 1/4"



Service Part No.	Description
B205010	Receptacle Boot
BE23201	Receptacle Assembly
BE23202	Plug Assembly with Spring Guard

## SINGLE POLE PLUG & RECEPTACLE TAILGATE CONNECTORS

- Plated Copper Grounding Lug.
- 300 Amp Capacity
- Plug Grounding Lug Accepts 4 Gauge Cable
- Receptacle Lug - Stud Hole Size 5/16"



Service Part No.	Description
B205010	Receptacle Boot
BE23101	Receptacle Assembly
BE23102	Plug Assembly with Spring Guard

## 7-Way Plugs & Receptacles (cont'd)

### CIRCUIT BREAKER STYLE RECEPTACLES WITHOUT HOUSING

- Receptacle only
- AMPS Ratings from 15 - 30 AMPS
- Mounting centers of 4 1/2" and an overall height of 2 1/2"
- Mounts in 4" opening
- Zinc plated split brass pins



Service Part No.	Description
BE24000	Receptacle Without Housing - Less Breaker
BE24015	15 AMP Receptacle Without Housing
BE24020	20 AMP Receptacle Without Housing
BE24030	30 AMP Receptacle Without Housing
BQ24002	Cover Assembly

### DIE CAST RECEPTACLE WITH LARGE MOUNTING PLATE

- Meets requirements of SAE J560
- Split pin, wire insertion
- Not equipped with circuit breakers
- Dedicated ground or ground connection is through mounting plate
- Gasket Included



Service Part No.	Description
BE16797	Metal Replacement Lid Kit
BE24120	Receptacle With Large Mounting Plate

### DIE CAST CIRCUIT BREAKER STYLE RECEPTACLE WITH POLY HOUSING

- AMPS Ratings from 15 - 30 AMPS
- Industry standard for trailer applications
- Zinc plated split brass pins
- Gaskets Included
- Housing Depth: 1 3/4"
- Overall Depth: 2 3/4"



Service Part No.	Description
BE24115	15 AMP
BE24120	20 AMP
BE24130	30 AMP

## 6-Way Plug & Receptacle

- Quality zinc casting with Engineering Grade Composite (EGC) inserts



BE23602 6-Way Receptacle

Service Part No.	Description
BE23603	6-Way Plug
BE23604	6-Way Plug With Spring Guard

## 4-Way Plug & Receptacle

- Quality zinc casting with Engineering Grade Composite (EGC) inserts



Service Part No.	Description
BE23402	4-Way Receptacle
BE23403	4-Way Plug
BE23404	4-Way Plug With Spring Guard

## 7-Way Terminal Cleaner

- One end for plug
- One end for receptacle
- Stainless steel brushes
- One-year warranty



Service Part No.  
BE20400



## Coiled Cables



12' Service Part No.	15' Service Part No.	Description	Gauge Wires	Leads
BE27039	BE27019	Black Light Duty Powercoil With Spring Guard - Non-ABS	1/12, 6/14	(2) 12"
BE27029	BE27031	Black Standard Duty Powercoil With Spring Guard - Non-ABS	1/10, 6/12	(2) 12"
BE17070	BE27071	Green Ultra Heavy Duty ABS Powercoil With Spring Guard	1/8, 2/10, 4/12	(2) 12"
n/a	BE27072	Green Ultra Heavy Duty ABS Powercoil With Spring Guard	1/8, 2/10, 4/12	(1) 12", (1) 48"
n/a	BE27073	Green Ultra Heavy Duty ABS Powercoil With Spring Guard	1/8, 2/10, 4/12	(1) 12", (1) 72"
n/a	BE27096	Yellow ABS and Auxiliary Plug Powercoil With Spring Guard	1/8, 2/10, 4/12	(2) 12"

## Electro-Pneumatic Switches

### LOW AIR SWITCH

- Actuates at 66 PSI
- Single pole, two terminal
- Circuit Position normally open
- 1/8-27 NPT Threads
- Available in 12V or 24V

Service Part No.  
BE13241



### TRACTOR SPRING BRAKE CIRCUIT LIGHT SWITCH

- Actuates at 55 PSI
- Single pole, two terminal
- Circuit Position normally closed
- 1/8-27 NPT Threads
- Available in 12V or 24V

Service Part No.  
BE13240



### TRAILER EMERGENCY STOPLIGHT SWITCH

- Actuates at 55 PSI
- Single pole, double throw, three terminal
- Circuit Position normally one open, one closed
- 1/8-27 NPT Threads
- Available in 12V or 24V

Service Part No.  
BE13255



### SERVICE CIRCUIT STOPLIGHT SWITCH

- Actuates at 3-5 PSI
- Single pole, two terminal
- Circuit Position normally open
- 1/4-18 NPT Threads
- Available in 12V or 24V

Service Part No.  
BE13250



## Electric Trailer Brake Controllers

### PRIMUS™ IQ BRAKE CONTROL

- Works proportionally in reverse
- No level adjustment necessary, adjusts to varying terrain as you drive
- Digital display shows voltage to trailer during braking
- Boost feature allows for customized braking
- Pre-assembled wire harness for simple hook-up and quick disconnect
- Diagnostic features incorporated in LED display
- Electric trailer brake Control for up to three axles
- Limited Lifetime Warranty (some conditions apply)

Service Part No.  
B90155



### VOYAGER BRAKE CONTROL

- Built to replace the Mark 12 (BE30212) and Mark 24 (BE30224)
- One-third the size of the Mark 12 and Mark 24
- Application for 2 or 4 wheel brakes

Service Part No.  
BE30227



# Single Conductor PVC

## SINGLE CONDUCTOR PVC PRIMARY WIRE

- SAE J1128 TYPE GPT
- 300 Volts
- Poly-vinyl insulation with superior abrasive strength
- Highly resistant to acid, grease, oil and gasoline
- Compounded to incorporate moisture resistance and desirable aging characteristics
- Standard package 100' spool (Also available in mini-spools)



Service Part No.	8 GAUGE Description
------------------	---------------------

BE28140	Black
BE28141	Red

Service Part No.	10 GAUGE Description
------------------	----------------------

BE28142	Black
BE28143	Blue
BE28145	Red
BE28147	White

Service Part No.	12 GAUGE Description
------------------	----------------------

BE28150	Black
BE28151	Blue
BE28152	Green
BE28153	Red
BE28154	Yellow
BE28155	White

Service Part No.	14 GAUGE Description
------------------	----------------------

BE28158	Black
BE28159	Blue
BE28160	Green
BE28161	Red
BE28162	Yellow
BE28163	White
BE28164	Brown

Service Part No.	16 GAUGE Description
------------------	----------------------

BE28166	Black
BE28167	Blue
BE28168	Green
BE28169	Red
BE28170	Yellow
BE28171	White
BE28172	Brown

Service Part No.	18 GAUGE Description
------------------	----------------------

BE28174	Black
---------	-------

## Primary Wire

### JACKETED TWO CONDUCTOR

- Meets SAE J1128, Type GPT specifications
- Black, White Conductor Color
- Covered with gray PVC jacket
- Standard package 100' spool



Service Part No.	Description
BE28820	16 Gauge
BE28821	14 Gauge
BE28822	12 Gauge

### JACKETED THREE CONDUCTOR

- Meets SAE J1128, Type GPT specifications
- Black, Green, Red Conductor Color
- Covered with gray PVC jacket
- Standard package 100' spool



Service Part No.	Description
BE28828	16 Gauge

## Multi-Conductor Wire

### BONDED THREE CONDUCTOR

- Meets SAE J1128, Type GPT specifications
- Brown, Yellow, Green Conductor Color
- Standard package 100' spool



Service Part No.	Description
BE28825	14 Gauge

### BONDED FOUR CONDUCTOR

- Meets SAE J1128, Type GPT specifications
- Brown, White, Green, Yellow Conductor Color
- Standard package 100' spool



Service Part No.	Description
BE28826	16 Gauge
BE28827	14 Gauge

# Battery Hardware

## POST TYPE HEAVY DUTY UNIVERSAL BATTERY TERMINAL

- 1/0 Gauge 3-way Top Terminal
- 1 Set (One Neg./One Pos.)

Service Part No.  
BE20179



## FLEET HEAVY DUTY UNIVERSAL BATTERY TERMINAL

- For temporary repair of battery terminals
- Universal, Clamp Type
- 2/0 To 4/0 Gauge Cable

Service Part No.  
BE20196



## COPPER LUG - CLOSED TYPE BATTERY TERMINAL



Service Part No.	Description
BE20140	4/0 Gauge; 1/2" Stud
BE20141	4/0 Gauge; 3/8" Stud
BE20142	3/0 Gauge; 1/2" Stud
BE20143	3/0 Gauge; 3/8" Stud
BE20144	2/0 Gauge; 3/8" Stud
BE20145	2/0 Gauge; 1/2" Stud
BE20147	1/0 Gauge; 3/8" Stud

## TOP POST - BATTERY TERMINAL

- Tin-plated Copper Alloy



Service Part No.	Description
BE20222	1/0 Positive
BE20223	1/0 Negative
BE20224	2/0 Positive
BE20225	2/0 Negative

## STUD NUTS - GROUP 31 BATTERIES

- Stainless Steel
- Universal polarity

Service Part No.  
BE20100



## REPLACEMENT BOLT AND NUT FOR 5011 SERIES

Service Part No.  
BE31805



## UNIVERSAL STYLE TERMINAL CONVERTER

Service Part No.  
BE31807



## HEAVY DUTY TRUCK JUMPER CABLES AND GROUND STRAPS



BE20166



BE20172/BE4910



BE31800/BE31801

Service Part No.	Description
BE20166	2/0 Gauge; 12"; Top Post to Top Post
BE20172	4/0 Gauge; 12"; Ground Strap
BE31800	2/0 Gauge; 8"; Anti-rotational Lugs; Top Stud to Top Stud
BE31801	2/0 Gauge; 12"; Anti-rotational Lugs; Top Stud to Top Stud
BE4910	4/0 Gauge; 18"; Ground Strap

## BOOSTER CABLE AND ACCESSORIES



Service Part No.	Description
BE38001	20' Booster Cable
BE38002	16' Booster Cable
BE38004	500 AMP Clamp Set

## WELDING CABLE

- High grade soft annealed copper conductor
- High strand count for superior flexibility
- Jacketed with an oil-resistant black neoprene cover



Service Part No.	Description
BE28810	4/0 Gauge, 25' Coil, .410" Nom OD, Min. 418 Strands
BE38002	2/0 Gauge, 25' Coil, .634" Nom OD, Min. 1273 Strands

## Battery Hardware (cont'd)

### BATTERY AND STARTER CABLES

- Conductors are made of high grade soft annealed copper
- High strand count for flexibility
- Meets the requirements of SAE J1127 - Type SGT
- Cable is jacketed with a specially formulated abrasion resistant PVC

25' COIL Service Part No.	100' COIL Service Part No.	Description	Nom. O.D.
BE28809	BE28815	4 Gauge/Red	0.346"
BE28816	BE28817	2 Gauge/Red	0.445"
n/a	BE28800	1 Gauge/Red	0.482"
BE28808	BE28802	1/0 Gauge/Black	0.514"
BE28805	BE28804	2/0 Gauge/Black	0.582"
BE28807	BE28806	3/0 Gauge/Black	0.662"
BE28818	n/a	4/0 Gauge/Black	0.740"

### BLACK NON-ABS TRAILER CABLES

- Up to 10% more copper content than required by SAE J1128
- High conductor strand count for excellent flexibility
- Flexibility down to temperatures of 85°F (-65°C)
- Up to three times more abrasion resistant than competitive cables

100' COIL Service Part No.	500' COIL Service Part No.	Description	Nom. O.D.
<b>LIGHT DUTY</b>			
BE28414	BE28415	4/14, 4-Way	0.420"
BE28614	BE28615	6/14, 6-Way	0.544"
BE28714	BE28715	6/14, 1/12, 7-Way*	0.554"
<b>STANDARD DUTY</b>			
BE28712	BE28715	6/12, 1/10, 7-Way	0.581"

\* Also available in 250' Coil (Service Part No. BE28727)

## Switches

### IGNITION KEY SWITCH

- Universal ignition starter switch
- 4 post connection
- Acc./off/on/start
- Waterproof o-ring sealed; pick proof lock

Service Part No.  
BE20097



### AXLE SHIFT SWITCH

- Two speed
- Zinc diecasting
- Rubber cover

Service Part No.  
BE20098



### MASTER DISCONNECT SWITCHES

- Lever operated
- S.P.S.T. OFF-ON
- Two Stud Terminals

Service Part No.  
BE20098

- D.P.S.T.
- For alternator or generator system

Service Part No.  
BE20098



### BUZZER

- Truck low air Pressure and bus rear door warning signal
- 12V - Two Screw Terminals

Service Part No. BE22638



### PUSH-PULL SWITCH (EXTRA HEAVY DUTY)

- S.P.S.T ON-OFF
- 75 AMP, 6-28 Volts
- Stem: 5/8" Long; 15/32" Dia. Thread
- Chrome Plated, Diecast Knob

Service Part No.  
BE20051



### TOGGLE SWITCH

- U/L Listing: 20 AMP
- S.P.S.T. ON-OFF - 2 Screws

Service Part No.  
BE20085



### MOMENTARY PUSH SWITCH

- 60 AMP @ 12V; 40 AMP @ 24V
- Weather and Dust Proof Construction
- Silver Contacts
- Flush terminal screws
- Stem: 5/8" Long; 5/8" Dia. Thread

Service Part No.  
BE20065



### STARTER SOLENOID

- 85 AMPS @ 12 V Continuous Duty
- Insulated Base
- Operating Coil Connections

Service Part No.  
BE68202



# Haldex Air Treatment Products +

## GEMINI<sup>MDx</sup>

Manifold Dual Dryer – High Capacity Drying System

- Easy installation and removal
- Lightweight
- Only four major connections for fewer leak points
- Two-Year dryer service interval
- Standard service parts inventory
- Best “contaminant-free” system on the market today

### DUAL DRYest / DUAL CONSEP



Service Part No.	DRYest Heater	CONSEP Heater	Silenced	Drain Tube	OEM Part No.
DA37061	24V	24V	X	-	N4265BC
DA37251	12V	12V	X	-	-

### DUAL DRYest

- DA37005 - SKF Replacement
- DA37100 - NOVA Bus



Service Part No.	DRYest Heater	CONSEP Heater	Silenced	Drain Tube	OEM Part No.
DA37500	24V	-	X	-	N4265DA
DA37100	24V	-	-	X	N4265AB
DA37200	12V	-	X	-	-

### DUAL DRYest / SINGLE CONSEP

- New Flyer Bus



Service Part No.	DRYest Heater	CONSEP Heater	Silenced	Drain Tube	OEM Part No.
DA37013	24V	12V	X	-	N4265AD

### DUAL CONSEP

- Open Drain
- Gillig Bus



Service Part No.	DRYest Heater	CONSEP Heater	Silenced	Drain Tube	OEM Part No.
DA39100	-	24V	-	-	N4265CF

### GeminiMDx SERVICE KITS

Service Part No.	Description	Application	Notes
DQ6100	Major Repair Kit - Dual CONSEP	DA37061 DA39100	24V
DQ6101	Major Repair Kit - Dual CONSEP	DA37251	12V
DQ6102	Rebuild Kit Dual Dryer with Drain Tube	DA37100	24V Includes Cartridges
DQ6103	Rebuild Kit Dual Dryer with Silencer	DA37005 DA37013 DA37061	24V Includes Cartridges
DQ6105	Rebuild Kit Dual Dryer with Silencer	DA37200 DA37251	12V Includes Cartridges
DQ6122	Minor Repair Kit CONSEP	DA37013	Services One CONSEP
DQ6123	Hose Assembly Dual Dryer/Dual CONSEP and Dual Dryer/Single CONSEP	DA37061 DA37251 DA37013	-

# Haldex Air Treatment Products (cont'd) +

## DRYest AIR DRYER

- Uses MTC+ 5-stage desiccant cartridge for superior drying and long service life
- Integrated turbo protection valve prevents loss of engine turbo
- Compact size makes installation easy, even as a drop-in dryer
- Built-in heater prevents freeze-ups
- Purge Tank Kit - Service Part No. 47010001



Service Part No.	Heater Voltage	System Regeneration	Internal Governor
DA35100	12 Volt	X	-
DA35105	24 Volt	X	-
DA35110*	12 Volt	-	-
DA35115*	24 Volt	-	-
DA35200	12 Volt	X	X
DA35205	24 Volt	X	X
DA35210*	12 Volt	-	X
DA35215*	24 Volt	-	X
DA35220*	n/a	-	X

\*For use with external purge tank.

## CONSEP CONDENSER/SEPARATOR

- Condenses and separates oil, water and other contaminants in compressed air line, substantially increasing desiccant life
- Includes Haldex Automatic Drain Valve (ADV)
- Ideal for transit and heavy braking applications
- Installs between compressor and air dryer, or can be used as a stand alone unit
- Purges contaminants with each brake application



Service Part No.	Description
41210026	12 Volt
41210029	24 Volt

## MTC+ Multi-Treatment Cartridge

- Serpentine path makes MTC+ more efficient and extends dryer service life
- Different sized desiccant creates over 26% more surface area than competitor's single desiccant cartridge
- Service is quick and easy with 4-bolt slide in-and-out design



Stage 1: Aluminum Mesh for solid particles  
 Stage 2: Large Desiccant for oil & water droplets  
 Stage 3: Medium Desiccant for oil & water vapor  
 Stage 4: Small Desiccant for water vapor  
 Stage 5: Dust Filter for ultra-fine particles

Service Part No.	Description
DQ6050	PURest MTC+ Kit
47178964	DRYest and ModulAir MTC+ Kit

## PURest AIR DRYER

- Uses MTC+ 5-stage desiccant cartridge for superior drying and long service life
- Includes universal mounting bracket
- Integrated turbo protection valve prevents loss of engine turbo
- MTC+ Cartridge attaches with only 4 bolts, making for easy servicing and time savings



Service Part No.	Description
DA34100	12 Volt Heater
DA34110	24 Volt Heater
DA34160	12 Volt Heater No Bracket
DA34200	12 Volt Heater with "Econ" Valve

## MODULAIR AIR DRYER

- Large MTC+ 5-stage desiccant cartridge eliminates more contamination than single stage competitors (9.2 SCF drying capacity)
- Heat resistant brass turbo protection valve lasts longer than plastic composite valves
- Complete plug-n-play changeover from Bendix® AD-IS system
- Three-year warranty



Service Part No.	Heater Voltage	System Regeneration	Internal Governor
DA36100	12 Volt & 24 Volt	X	X
DA36200	12 Volt & 24 Volt	Requires Ext Purge	X

## EXTERNAL PURGE TANK KIT FOR MODULAIR



Service Part No.	Description
DQ6058	Kenworth T Series
DQ6060	Kenworth W 900 Series
DQ6061	Navistar Pro Series
DQ6063	Peterbilt
DQ6064	Kenworth (Behind the Cab)

## ALCOHOL EVAPORATOR

- Easy to install
- Holds 40 oz. of Methyl Alcohol
- Pressure protected
- The alcohol evaporator is an automatic vaporizing device for keeping air lines and air reservoirs free of ice



Service Part No. A72420

# Haldex Air Treatment Products (cont'd) +

## HALDEX FILTER CARTRIDGE (HFC) WITH COALESCING FILTER

Haldex has combined the properties of an annular pre-filter, a powerful coalescing filter and high-performance desiccant to create our best drying unit yet. During normal use, the HFC prevents moisture and contaminants from entering the compressed air system. This reduces air system component wear and increases the reliability and availability of the vehicle.

Service Part No.  
031005609



Dryer Type	Application
WABCO SS1200 Dryer Series	955205, 955205X, 955206X 955300X, 955315X
Bendix® AD-IS and AD-SP Dryers	109991X, 109992X, 5004050X 5010696X, 800973X
Bendix® Direct Replacement	5008414PG
WABCO Direct Replacement	R9550068
Bendix® Upgrade	109994, 5008414
WABCO Upgrade	R950011
Haldex Upgrade	109994K, 5008414K, 950011K

## Bendix® AD-SP AIR DRYERS WITH HALDEX FILTER CARTRIDGE (HFC) WITH COALESCING FILTER



Service Part No.	Service Part No. With HFC
109991X	109991CX
109992X	109992CX

## Bendix® AD-IS AIR DRYERS WITH HALDEX FILTER CARTRIDGE (HFC) WITH COALESCING FILTER



Service Part No.	Service Part No. With HFC
5004050X	5004050CX
5010696X	5010696CX

## WABCO SS1200 SERIES AIR DRYER WITH HALDEX FILTER CARTRIDGE (HFC) WITH COALESCING FILTER



Service Part No.	Service Part No. With HFC
955205X	955079CX
955205RX	955079CRX
955206X	955206CX
955300X	955300CX
955315X	955315CX

## PRESSURE CONTROLLED CHECK VALVE (PCCV)

Service Part No.  
S4341003100



S4341003100

## WABCO SS1200 SERIES AIR DRYER WITH PCCV

Service Part No. With PCCV	Part Description
955205K	NEW WABCO SS1200 Air Dryer Replacement with PCCV
955205KRX	CORE FREE WABCO SS1200 Air Dryer Replacement with PCCV
955205KX	REMAN SS1200 Air Dryer Replacement with PCCV
955206KX	REMAN WABCO SS1200 Air Dryer with Coalescing Filter Replacement with PCCV

# New and Remanufactured Bendix® Air Dryers & Cartridges +



109477X



109685X



109991X



5004050X



65041X

Service Part No.	Supply	Delivery	Air Inlet	Heater Voltage	Notes
AD-4 65041X	1/2"	1/2"	1/4"	12 Volt	AD-4 Cartridge - 104358X AD-4 Fleet Service Kit - 104348MKX

Service Part No.	Supply	Delivery	Air Inlet	Heater Voltage	Notes
AD-9 65224	1/2"	3/4"	1/4"	24 Volt	New AD-9 Dryer Soft Seat Purge
AD-9 65225	1/2"	1/2"	1/4"	12 Volt	New AD-9 Dryer
AD-9 109685X	1/2"	1/2"	1/4"	12 Volt	AD-9 Cartridge - 107794X AD-9 Fleet Service Kit - 107794MKX

Service Part No.	Supply	Delivery	Air Inlet	Heater Voltage	Notes
AD-IP 109477RX	1/2"	1/2"	1/4"	12 Volt	CoreFree AD-IP Cartridge - 109493RX
AD-IP 109477X	1/2"	1/2"	1/4"	12 Volt	Reman AD-IP Cartridge - 109493X New AD-IP Cartridge - 65624K

Service Part No.	Supply	Delivery	Air Inlet	Heater Voltage	Notes
AD-IS 5004050X	1/4"	1/4"	1/4"	12 Volt	New AD-IS Cartridge - 5008414K
AD-IS 5010696X	1/4"	1/4"	1/4"	12 Volt	AD-IS with Extra Purge Volume

Service Part No.	Supply	Delivery	Air Inlet	Heater Voltage	Notes
AD-SP 109991X	1/2"	1/2"	1/4"	12 Volt	New AD-SP Cartridge - 109994K AD-SP Purge Valve Kit - 109995K

## Bendix® AD-IS Governor/Check Valve Replacement Kit



- Non-adjustable governor and check valve made specifically for use with the Bendix® AD-IS Air Dryer

Service  
Part No.  
5004049K

## WABCO Air Dryers



SS1200

Service Part No.	Supply	Delivery	Control	Heater Voltage	Notes
955205	1/2"-14 FPT	1/4"-18 FPT	1/4"-18 FPT	12 Volt	New SS1200 Compact Air Dryer
955205X	1/2"	1/2"	1/4"	12 Volt	SS1200 Cartridge - 950011K



## Like-Nu Remanufactured Carrier A/C Compressors +

### Unparalleled Product End-Of-Line and Component Testing

- All cylinders are resurfaced using the latest CNC honing equipment with custom fixtures to prevent uneven surfaces within the cylinder walls
- All compressors assembled using the most accurate, high-end DC Torque Control on all critical fasteners
- All units undergo no-load testing for build-up
- All units vacuum leak tested with state-of-the-art LeakMaster testing equipment
- All internal parts inspected and replaced if not within OE tolerances
- Oil pumps are tested for proper output during operation and replaced if necessary
- One Year Warranty

### Remanufactured Carrier A/C Compressor 05G Ultra

- Trailer Reefer Applications

Service  
Part No.  
R5G6T41AUX



### Remanufactured Carrier A/C Compressor 05G

- Transit Bus, Coach, Bus Applications

Service  
Part No.  
R5G6T41ABX



## Coiled Air Hoses

- Coiled, 1/2" O.D., reinforced nylon tubing
- Excellent coil memory and durability
- Color coding (red-emergency / blue-service); Meets SAE J844 and DOT FMVSS 106
- 1/2" NPT each end
- Male pipe - brass fittings; heavy duty plated spring guards
- Designed for 150 PSI operating systems
- Resistant to attack by gasoline, diesel fuel, methyl-alcohol and zinc chloride
- Working temperature range is -40°F to +199°F
- Sets include one red and one blue coil



Service Part No.	Description
11950	12'; 6" Lead
11952	15'; 12" Lead
11954	15'; (1) 48" Lead; (1) 12" Lead
11956	20'; (1) 48" Lead; (1) 12" Lead

Additional information is available in the Haldex Master Catalog ([haldex.com](http://haldex.com)).

## Reservoirs

### SADDLE-MOUNTED, SINGLE COMPARTMENT

- Long life internal and external corrosion protection
- Conform to SAE J10B specs
- Certified to 150 PSI working Pressure
- 1/4" drain port in bottom
- Two 3/8" charging ports, one each end



Service Part No.	Volume	Valve Mounting Port	Diameter	Mounting Center
19810	1425 Cu. In.	(1) 3/4"	8"	32"
19820	2865 Cu. In.	(2) 3/4"	12"	29 1/2"
19840	1490 Cu. In.	(2) 3/4"	9 1/2"	27 1/2"

# Gladhands

## CONVENTIONAL STYLE

- Economical heavy duty gladhand available in aluminum body/steel face or cast iron body
- Polarized and color coded in service configuration for easy identification of airlines
- Interchangeable with most competitive gladhands.
- Aluminum/Steel units come with Internal filter installed to protect airline from contamination



Dual Lip Seal



Compression Seal



Service Part No.	Description	Seal Service Part No.
11450	Aluminum/Steel - Universal	10028
11452	Aluminum/Steel - Service	10028
11461	Aluminum/Steel - Emergency	10028
A7770	Cast Iron - Service	10029
A77771	Cast Iron - Emergency	10029
A86300	Cast Iron - Universal	10029

## BRACKET MOUNT STYLE

- Bracket mount eliminates the need for additional mounting panels, lowering overall cost
- Heavy duty design projects 3.95" from mounting surface
- Polarized and color coded in service configuration for easy identification of airlines
- Includes 10028 Dual Lip Seal, 10035 Filter and loose 3/8" or 1/2" plug



Service Part No.	Description	Ports
11440	Service	3/8-18
11441	Emergency	3/8-18
11444	Service	1/2-14
11445	Emergency	1/2-14

## QRG (QUICK RELEASE GLADHAND)

- Unique patented design with built-in quick release valve
- Heavy Duty aluminum body and steel face
- Zinc yellow dichromate steel and chromate conversion coated aluminum
- Improves brake release timing by up to 67%
- Replaces service gladhands on the nose of the trailer



Nipple Mount



Bracket Mount

Service Part No.	Description
11483	Nipple Mount
11484	40° Bracket Mount
RN58A	Repair Kit

## Gladhand Grips

- Color-coded plastic handle
- Stainless steel screws
- Non-slip hex-shaped body is made from a high-impact UV-resistant polymer (shatter-proof)
- Inside edges are beveled which eliminates the hose-chafing sharp edge common in other designs



Service Part No.	Description
11405	Pair - one red/one blue

Additional information is available in the Haldex Master Catalog ([haldex.com](http://haldex.com)).

# Air Hoses

## AIR HOSE ASSEMBLIES 3/8" I.D. x 3/4" O.D.

- Type B - permanent fittings
- Made in strict accordance with SAE J1402 and DOT 106 specs.

1/4" Ends 1 Fixed/1 Swivel		3/8" Ends Both Swivel		3/8" Ends 1 Fixed/1 Swivel	
Svc. Part No.	Length	Svc. Part No.	Length	Svc. Part No.	Length
16014	14"	16418	14"	16618	14"
16016	16"	16420	16"	16620	16"
16018		16424		16622	
16020		16428		16624	
16022		16430		16626	
16024		16436		16628	
16026		16442		16630	
16028		16448		16632	
16030		16460		16634	
16032				16636	
16034				16638	
16036				16640	
16038				16642	
16040				16644	
16042				16646	
16044				16648	
16046				16654	
16048				16660	
16054				16672	
16060				16060	
16072					

## AIR HOSE ASSEMBLIES 1/2" I.D. x 7/8" O.D.

- Type B - permanent fittings
- Made in strict accord with SAE J1402 and DOT 106 Specs.
- Hose Rack - Service Part No. 200997B
- Assortment with hose rack - Service Part No. DQ16002

3/8" Ends 1 Fixed/1 Swivel		3/8" Ends Both Swivel		1/2" Fixed End 3/8" Swivel End	
Svc. Part No.	Length	Svc. Part No.	Length	Svc. Part No.	Length
16316	14"	16718	14"	16820	14"
16318	16"	16720	16"	16824	16"
16320		16722		16830	
16322		16724		16836	
16324		16726		16848	
16326		16728		16860	
16328		16730		16872	
16330		16732			
16332		16734			
16334		16736			
16336		16738			
16338		16740			
16340		16748			
16342		16756			
16344		16772			
16346					
16348					
16352					
16354					
16356					
16360					
16372					

## Midland ConnectSet 3IN1 tractor-to-trailer connection set

- Designed for flexibility, durability and secure connections
- Midland Action Grip (MAG) flexibility prevents kinked air lines
- ABS optimized 7-way cable paired with heavy-duty plugs
- Rugged, dual-braided D.O.T. air lines meet SAE J1402 and FMVSS No. 106 compliance
- Heavy-duty spiral wrap protects your lines from daily wear and tear
- Stainless-steel hanger clamp ensures corrosion free performance



Service Part No.	Description
MCP308S	8'
MCP310S	10'
MCP312S	12'
MCP313S	13.5'
MCP315S	15'
MCP320S	20'

# Air Hose Fittings and Accessories

## HOSE END FITTINGS - USE WITH BULK 3/8" I.D. HOSE



11906      11907, 11908, 11909      11910



11911      11912      11914

Service Part No.	Description
11906	Nut for fitting without spring
11907	Body, 1/4-NPT
11908	Body, 3/8-NPT
11909	Body, 1/2-NPT
11910	Nut for fitting with spring
11911	Spring
11912	Ferrule
11914	Union fitting body

## RENEWABLE HOSE END FITTING ASSEMBLIES - USE WITH 3/8" I.D. HOSE



11900, 11901, 11902      11903, 11904, 11905      11913

Service Part No.	Description
11900	Male end with spring, 1/4-NPT
11901	Male end with spring, 3/8-NPT
11902	Male end with spring, 1/2-NPT
11903	Male end without spring, 1/4-NPT
11904	Male end without spring, 3/8-NPT
11905	Male end without spring, 1/2-NPT
11913	Hose Union

## AIR LINE FILTER ASSEMBLIES

- Removable and replaceable filter element
- Can be used in both emergency/service lines

Service Part No.	Description
11480	Complete Assembly
N12971B	Replacement Filter
RN13A	Repair Kit



# Accessories

## FLEXASTIKS - ZINC DICHROMATE FINISH

- OE hose support pogo sticks
- Available with spring only, or with various mounting items



Service Part No.	Length	Service Part No. Hose Clamp	Service Part No. Support Bracket	Service Part No. Hose Ring
11500	41"	11547	-	-
11501	41"	11547	11403	-
11502	41"	-	-	11611
11503	41"	-	11403	11611
11504	51"	11547	-	-
11505	51"	11547	11403	-
11506	51"	-	-	11611
11507	51"	-	11403	11611
11508	41"	-	-	-
11509	51"	-	-	-

## SUPPORT SPRINGS - ZINC DICHROMATE FINISH



Service Part No.	Length	Coil O.D.
11600	25 1/2"	1 1/8"
11601	13"	3/4"
11602	13"	1"
11603	16"	1 1/16"

## HOSE SEPARATORS

- Molded White (EGC) Engineering Grade Composite
- Snap Connect



Service Part No.	Description
11548	For 3/8" I.D. Hose
11549	For 1/2" I.D. Hose

## HOSE SUPPORT BRACKET

- For current design flexastiks

Service Part No.  
11403



## HOSE COUPLER WITH CHAIN

- Zinc & Yellow Dichromate Body



Service Part No.	Description
11401	With vent hole
11402	Without vent hole

## HOSE CLAMPS



11540



11541



11542



11543



11544



11545



11546



11547



11611



11615

Service Part No.	Description
11540	2-hole, 3/8" I.D.
11541	2-hole, 3/8" I.D., rubberized for coiled airlines
11542	3-hole, 3/8" I.D.
11543	3-hole, 3/8" I.D.
11544	3-hole, 3/8" I.D., rubberized for coiled airlines
11545	3-hole, 3/8" & 1/2" I.D.
11546	3-hole, 3/8" & 1/2" I.D.
11547	3-hole, 3/8" & 1/2" I.D.
11611	Hose ring assembly, 3/8" & 1/2" I.D.
11615	Stainless steel hanger, use with ABS power lines

# Haldex Manual Brake Adjusters +

## MANUAL BRAKE ADJUSTERS - STRAIGHT ARM

- Forged steel
- 26,000 in. lbs.
- Bi-directional design
- Clevis Bushing Service  
Part No. 45210129

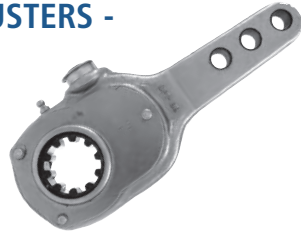

Service Part No.	Arm Length	Spline
KN44041	6.0	1 5/8" - 37
KN44051	5.0, 6.0	1 1/2" - 28
KN44061	5.5, 6.5	1 1/2" - 28
KN47001	5.0, 6.0, 7.0	1 1/2" - 10
KN47002	4.5, 5.5	1 1/2" - 10
KN47011	5.5, 6.5	1 1/2" - 10
KN47081	5.0, 6.0	1 1/2" - 10
KN48001	5.0, 6.0	1 1/4" - 10
KN48031	4.5, 5.5	1 1/4" - 10
KN52040	4.0, 5.0	1 1/4" - 40
KN52050	5.5	1 1/2" - 48
KN52060	4.0, 5.0	1 1/2" - 48
KN55001	5.5	1 1/4" - 24

## MANUAL BRAKE ADJUSTERS - 5/8" OFFSET ARM

- Ductile iron
- 20,000 in. lbs.
- Right and left hand
- Clevis Bushing Service  
Part No. 45210129

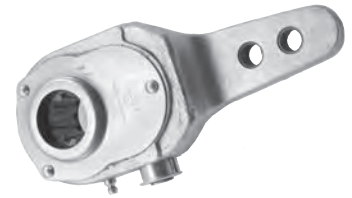

Service Part No.	Arm Length	Spline
KN49000 RH	4.5, 5.5	1 1/4" - 10
KN49010 LH	4.5, 5.5	1 1/4" - 10
KN49020 RH	4.0, 5.0, 6.0	1 1/4" - 10
KN49030 LH	4.0, 5.0, 6.0	1 1/4" - 10
KN50000 RH	4.5, 5.5	1 1/2" - 10
KN50010 LH	4.5, 5.5	1 1/2" - 10
KN50060 RH	4.0, 5.0, 6.0	1 1/2" - 10
KN50070 LH	4.0, 5.0, 6.0	1 1/4" - 10
KN53000 RH	5.0, 6.0	1 1/2" - 28
KN53010 LH	5.0, 6.0	1 1/2" - 28
KN53020 RH	5.5	1 1/2" - 28
KN53030 LH	5.5	1 1/2" - 28
KN54000 RH	5.5	1 1/4" - 24
KN54010 LH	5.5	1 1/4" - 24

## Haldex Automatic Brake Adjuster Quick-Reference Guide

	Arm Length	Spline	Anchor Bracket Style	ABA Kit Service Part No.	S-ABA Kit Service Part No.
<b>Standard Application Tractor</b>	6.0	1 1/2" - 28	Strap	40010140	4020234
	5.5	1 1/2" - 28	Strap	40010141	40020231
	5.0, 6.0	1 1/2" - 10	Strap	40010142	40020233
	5.5	1 1/2" - 10	Strap	40010143	40020228
<b>Mack Truck Applications</b> (with 3" and longer camshaft tubes)	6.0	1 1/2" - 28	Clamp	40010144	40020243
	6.0	1 1/2" - 28	Spider Mounted	40010067*	n/a
	5.5	1 1/2" - 28	Clamp	40010146	n/a
	6.0	1 1/2" - 10	Clamp	40010145	40020244
<b>Meritor Air Disc Brake</b>	5.5	1 1/2" - 28	Strap	40010402	n/a
	6.0	1 1/2" - 10	Strap	40010637	n/a
<b>Kenworth with 8 Bag Air Ride</b> (to avoid interference with air bag supports)	5.5	1 1/2" - 28	Strap	40010156	n/a
	5.5	1 1/2" - 10	Strap	40010155	40020238
<b>Trailer</b>	6.0	1 1/2" - 28	Plate & Flat Stud	40010212	40020212
	5.5	1 1/2" - 28	Plate & Flat Stud	40010211	40020211
	6.0	1 1/2" - 10	Plate & Flat Stud	40010216	40020216
	5.5	1 1/2" - 10	Plate & Flat Stud	40010215	40020215
	5.5	1 5/8" - 37	Plate & Flat Stud	40010213	40020213
	6.0	1 5/8" - 37	Plate & Flat Stud	400102145.5	40020214

\* For Mack short camshaft tube, 2" or less.

## Haldex AA1 Automatic Brake Adjusters +

- Installation indicator confirms correct installation
- Chrome-moly gears and a buttress tooth configuration on the gears reduce stress and prolong service life
- Compatible with all major brand clevises
- Heat treated components reduce internal wear and provide longer service life
- 1,000,000 Mile, 6 year on-highway warranty



Arm Length	Spline	Anchor Bracket Style	Service Part No.
6.0	1 1/2" - 28	Spider Mounted	40010067*
5.0, 6.0	1 1/2" - 28	Strap	40010140
5.5	1 1/2" - 28	Strap	40010141
6.5	1 1/2" - 28	Strap	40050003
5.0, 6.0	1 1/2" - 10	Strap	40010142
5.5	1 1/2" - 10	Strap	40010143
6.5	1 1/2" - 10	Strap	40050004
6.0	1 1/2" - 28	Clamp	40010144**
6.0	1 1/2" - 10	Clamp	40010145
5.5, 6.5	1 1/2" - 28	Clamp	40010146

Arm Length	Spline	Anchor Bracket Style	Service Part No.
5.5	1 1/2" - 10	Strap	40010155
5.5	1 1/2" - 28	Strap	40010156
5.5	1 1/2" - 28	Plate & Flat Stud	40010211
6.0	1 1/2" - 28	Plate & Flat Stud	40010212
5.5	1 5/8" - 37	Plate & Flat Stud	40010213
6.0	1 5/8" - 37	Plate & Flat Stud	40010214
5.5	1 1/2" - 10	Plate & Flat Stud	40010215
6.0	1 1/2" - 10	Plate & Flat Stud	40010216
5.5	1 1/2" - 28	Strap	40010402
6.0	1 1/2" - 10	Strap	40010637

\* For Mack short camshaft tube, 2" or less.

\*\* For Mack truck with 3" and longer camshaft.

## Haldex S-ABA Automatic Brake Adjuster

- Incorporates AA1 High Standard Features. Plus Centralized Clutch and Unique Self-Setting Design

Arm Length	Spline	Anchor Bracket Style	S-ABA Service Part No.	Bracket Service Part No.
5.5	1 1/2" - 28	Plate & Flat Stud	40020211	42710563
6.0	1 1/2" - 28	Plate & Flat Stud	40020212	42710563
5.5	1 5/8" - 37	Plate & Flat Stud	40020213	42710563
6.0	1 5/8" - 37	Plate & Flat Stud	40020214	42710563
5.5	1 1/2" - 10	Plate & Flat Stud	40020215	42710563
6.0	1 1/2" - 10	Plate & Flat Stud	40020216	42710563
5.5	1 1/2" - 10	Strap	40020228	42710543
5.5	1 1/2" - 28	Strap	40020231	42710553
6.0	1 1/2" - 10	Strap	40020233	42710553
6.0	1 1/2" - 28	Strap	40020234	42710553
5.5	1 1/2" - 10	Strap	40020238	42710554
6.0	1 1/2" - 28	Clamp	40020243	42710566
6.0	1 1/2" - 10	Clamp	40020244	42710566

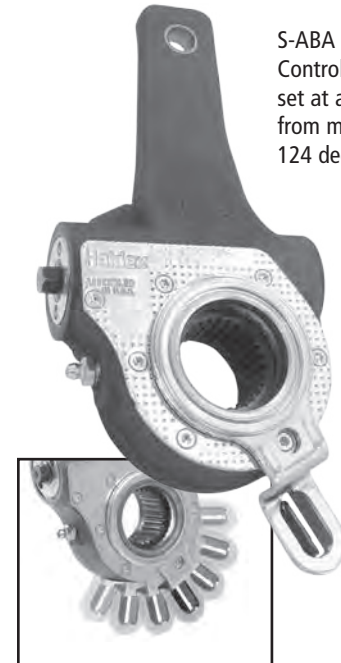

S-ABA allows the Control arm to be set at any angle from minus 16 to 124 degrees.

Consult the Haldex Master Catalog ([haldex.com](http://haldex.com)) for a complete listing of Brake Adjusters offered.

## Haldex Air Disc Brakes

### ModuLT



- Optimized for lighter weight while maintaining strength and durability
- Single piston mechanism with similar clamping force distribution as the Haldex twin piston mechanism
- Simplified maintenance, secure boltless pad retainer and only two bolts for the complete disc brake caliper assembly
- Modular: the same mechanism and sliding function design used on multiple brake sizes
- Long service life: stainless steel slide pins, PTFE coated bushings and the mechanism seal is folded inward so it is protected from external damage
- High efficiency: the use of double roller bearings for the mechanism lever keeps the hysteresis low and achieves a high efficiency

Service Part No.	Description
<b>ModuLT</b>	
790-95446	ADB Trailer, 22, RH, Wide, With Carrier and Pads
790-95447	ADB Trailer, 22, LH, Wide, With Carrier and Pads
790-95620	ADB Trailer, 22, LH, Standard, No Carrier/No Pads
790-95621	ADB Trailer, 22, RH, Standard, No Carrier/No Pads
790-95692	ADB Trailer, 22, RH, Standard, With Carrier and Pads
790-95693	ADB Trailer, 22, LH, Standard, With Carrier and Pads
790-97270	ADB Trailer, 22, RH, Standard, With Carrier/No Pads
790-97271	ADB Trailer, 22, LH, Standard, With Carrier/No Pads

### ModuLX™



- High performance for shorter stopping distance and improved control vs. drum brakes
- Modular design for common parts across the product range
- Four stainless steel pins for superior caliper guidance and reliability
- Unhanded design fits left and right hand side with one stocking part number
- High efficiency, low hysteresis application mechanism with clearance sensing adjuster

Service Part No.	Description
<b>ModuLX</b>	
790-92799	ADB Truck/Trailer, 22, Universal, Standard, With Carrier/No Pads
790-94025	ADB Trailer, 22, Universal, Standard, With Carrier/No Pads
790-94049	ADB Truck, 22, Universal, Dana, With Carrier/No Pads
790-94829	ADB Trailer, 22, Universal, Wide, With Carrier/No Pads

# New and Remanufactured Water Pumps +

## CATERPILLAR ENGINE - 3208

- Bolt On Pulley

Service Part No.  
RW1162 (new)  
RW1162X (reman)



## CHEVY/GMC - 2007-2013

5.3, 6.0, 6.2L

- Light/Medium Duty Engine

Service Part No.  
RW1939 (new)



## CATERPILLAR ENGINE 3406 B/C

- Flat Gear

Service Part No.  
RW1194 (new)  
RW1194BPK (back plate kit)  
RW1194PX (premium reman)



## CUMMINS ENGINE - BIG CAM III

- Multi-Groove Pulley

Service Part No.  
RW1170 (new)  
RW1170X (reman)



## CHEVY/GMC - 1999-2006

5.3, 6.0, 6.2L

- Light/Medium Duty Engine

Service Part No.  
RW1652 (new)



## CUMMINS ENGINE - SMALL CAM

- 2-Groove Pulley

Service Part No.  
RW1171 (new)  
RW1171X (reman)



## CUMMINS IDLER - BIG CAM

- Multi-Groove Pulley

Service Part No.  
RW1973 (new)  
RW1973X (reman)



## DODGE - 1994-2003 5.9, 5.7L

- Includes Bypass Tube

Service Part No.  
RW1438 (new)



## CUMMINS ENGINE - BIG CAM IV

- Multi-Groove Pulley

Service Part No.  
RW1172 (new)  
RW1172X (reman)



## DODGE - 2003-2008 5.7

Service Part No.  
RW181747 (new)



## CUMMINS IDLER - SMALL CAM

- 2-Belt Pulley

Service Part No.

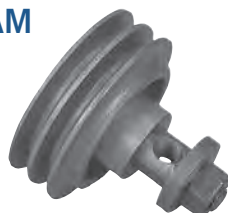

## FORD 1997-2013 4.6, 5.4L

- Light/Medium Duty Engine

Service Part No.  
RW1694 (new)





# New and Remanufactured Water Pumps (cont'd) +

## CUMMINS 2007 ISB

Service Part No.  
RW2060 (new)



## ISUZU 1992-1998 NPR 3.9L

- Without Bypass Tube

Service Part No.  
RW1907 (new)



## CUMMINS KIT - BIG CAM

Service Part No.  
RW3000 (new water pump idler kit)



## ISUZU 1987-1991 NPR 4BD2

- With Bypass Tube

Service Part No.  
RW1908 (new)



## DDC - 60 SERIES

- Gear Driven; Premium Seal

Service Part No.  
RW4122PLK (plastic backing plate kit)  
RW4122STK (steel backing plate kit)  
RW4123PX (premium reman)  
RW4123X (reman)



## MACK ENGINE - MAXIDYNE

- 1.57" Long Shaft; No Pulley

Service Part No.  
RW2001 (new)  
RW2001X (reman)

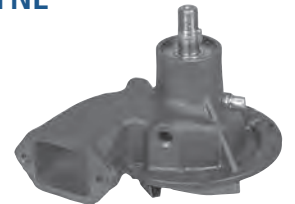

## MACK ENGINE - ECONODYNE

- Charged Air; No Pulley

Service Part No.  
RW2002 (new)  
RW2002X (reman)



## NAVISTAR ENGINE - DT466

- Belt Driven

Service Part No.  
RW6313 (new)  
RW1310X (reman)



## MERCEDES - MBE904 4.8L, MBE902 4.3L

- Bus

Service Part No.  
RW2044 (new)  
RW1438 (new)



## NAVISTAR ENGINE - Maxxforce 9.0L, 10.0L

Service Part No.  
RW2052 (new)



Haldex offers a complete line of New and Remanufactured Water Pumps. Please consult the Haldex Master Catalog ([haldex.com](http://haldex.com)) for a complete listing of the water pump product offering.

# Haldex ABS INTELLIGENT TRAILER CONTROL MODULE (ITCM)

- ITCM ECU is 12V, self-configurable and flash upgradable
- 2S/1M, 2S/2M, 4S/2M and 4S/3M ABS configurations
- Available in Full Function (FFABS) and Relay Valve ABS platforms
- Communication Support includes CAN and PLC
- Expanded Diagnostics and Fleet+
- Auxiliary features include: Trailer Roll Stability, Trailer Lift Axle Control and Brake Monitoring System (BMS3)

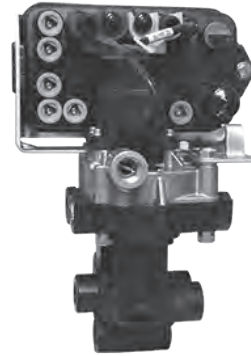

## PRIMARY CHANGE-OUT KITS

Service Part No.	Valve Type	Application	ECU/Valve OEM Part No.	Kit Contents
AQ965001	4-Port FFABS Spring Brake Priority, 6-Port ABS Relay	Tri-Axle, 4S/2M	N9004BC	6.0M Power Cord Extension, 2.0M Relay Valve Cable, 1.5M & 2.5M Sensor Extensions, Second 6-Port ABS Relay Valve, QRV, Hose Clips, Cable Grips
AQ965002	2-Port ABS Relay Reservoir Mount (Two Units)	Tandem Axle, 4S/2M	N9004C	6.0M Power Cord Extension, 2.0M Relay Valve Cable, 1.5M & 2.5M Sensor Extensions, Second 2-Port ABS Relay Valve, Hose Clips, Cable Grips
AQ965003	6-Port ABS Relay Reservoir Mount (Two Units)	Tri-Axle, 4S/2M	N9004AA	6.0M Power Cord Extension, 2.0M Relay Valve Cable, 2.0M & 3.0M Sensor Extensions, Second 6-Port ABS Relay Valve, Hose Clips, Cable Grips
AQ965004	2-Port FFABS Spring Brake Priority, 2-Port ABS Relay	Tandem Axle, 4S/2M	N9004BB	6.0M Power Cord Extension, 2.0M Relay Valve Cable, 1.5M & 2.5M Sensor Extensions, Second 2-Port ABS Relay Valve, Hose Clips, Cable Grips
AQ965005	4-Port FFABS Service Brake Priority, 6-Port ABS Relay	Tri-Axle, 4S/2M	N9004CA	6.0M Power Cord Extension, 2.0M Relay Valve Cable, 1.5M & 2.5M Sensor Extensions, Second 6-Port ABS Relay Valve, QRV, Hose Clips, Cable Grips
AQ965006	2-Port FFABS Service Brake Priority, 2-Port ABS Relay	Tandem Axle, 4S/2M	N9004CB	6.0M Power Cord Extension, 2.0M Relay Valve Cable, 1.5M & 2.5M Sensor Extensions, Second 2-Port ABS Relay Valve, Hose Clips, Cable Grips

## AUXILIARY KITS

Service Part No.	Application	Kit Contents
AQ968400	Trailer Roll Stability	Haldex Stability Module (NPTF), 1.0m CAN Cable
AQ968401	Trailer Roll Stability	Haldex Stability Module (NPTF), 2.5m CAN Cable
AQ25000	BrakeMonitoring System (BMS3)	(2) Pressure Switch Cables, Alarm with Cable, Bracket, Miscellaneous Hardware
62101011	Lift Axle Control	ILAS-E+ Valve, Pressure Transducer Kit, 2.0m Cable
AQ15900	Diagnostic+ Kit	Diagnostic Cable, PC Interface Dongle, USB Cable

## UPGRADE ECU KITS

Service Part No.	Application	Kit Contents
AL919353	ITCM ECU A7	ITCM ECU, Bracket, Hardware
AL919354	ITCM ECU A8	ITCM ECU, Bracket, Hardware

# Haldex ABS (Anti-Lock Braking System) Valves +

## 2S/1M ABS RELAY VALVE KIT

- ECU Design - PLC Select



Service Part No.	Valve Type	Application	Voltage	Res. Port	Cont. Port	Del. Port	Kit Contents
AQ960505	2-Port ABS Relay	Dolly & Single Axle	12V	1/2"	3/8"	3/8"	6.0M Power Cord Extension, 2.5M Full Sensors (90°) and Retaining Sleeve

## 2S/1M FFABS VALVE KITS

### Multi-Axle Applications

- Pre-installed reservoir nipple with swivel and locknut feature assures easy serviceability
- ECU and ABS Valve are designed to be serviced separately

AQ960802  
Shown



Service Part No.	Valve Type	Application	Voltage	Res. Port	Cont. Port	Del. Port	Kit Contents
AQ960208	4-Port FFABS	Trailer Non-Steer Axles	12V	3/8"	3/8"	3/8"	Spring Brake Priority, Dual Nipple 1/2" and 3/4" Nipple, 20M Power Cord with 12M ABS Lamp Lead, Two - 2.5M Full Sensors (90°), Clips and Retaining Sleeve
AQ960802	4-Port FFABS	Trailer Non-Steer Axles	12V	3/8"	3/8"	3/8"	Spring Brake Priority, Dual Nipple 1/2" and 3/4" Nipple, 20M Power Cord with 12M ABS Lamp Lead, ABS Light Kit, 2.5M Sensor Extensions
AQ961402	4-Port FFABS	Trailer Non-Steer Axles	12V	3/8"	3/8"	3/8"	Spring Brake Priority, Dual Nipple 1/2" and 3/4" Nipple, 2.5M Sensor Extensions
AQ961404	4-Port FFABS	Trailer Non-Steer Axles	12V	3/8"	3/8"	3/8"	Spring Brake Priority, Dual Nipple 1/2" and 3/4" Nipple, 6.0M Power Cord Extension, 2.5M Sensor Extension
AQ961405	4-Port FFABS	Trailer Non-Steer Axles	12V	3/8"	3/8"	3/8"	Service Brake Priority, Dual Nipple 1/2" and 3/4" Nipple, 5.0M Power Cable, Two - 2.0M Sensor Extensions, ABS Light Kit
AQ961406	4-Port FFABS	Trailer Non-Steer Axles	12V	3/8"	3/8"	3/8"	Service Brake Priority, Dual Nipple 1/2" and 3/4" Nipple, 5.0M Power Cable, Two - 2.5M Full Sensors (90°), Clips and Retaining Sleeve, ABS Light Kit

## 4S/2M ABS RELAY OR FFABS VALVE KITS

### New Trailer Build Applications

- ECU and ABS Valve are designed to be serviced separately
- ECU Design - PLC Select 2M

AQ963013  
Shown



Service Part No.	Valve Type	Application	Voltage	Res. Port	Cont. Port	Del. Port	Kit Contents
AQ963004	2-Port ABS Relay	Tandem Axles	12V	1/2"	3/8"	3/8"	6.0m Power Cord Ext., 1.5m and 2.5m Sensor Ext.
AQ963005	6-Port ABS Relay	Tri-Axles	12V	1/2"	3/8"	3/8"	6.0m Power Cord Ext., 2.0m and 3.0m Sensor Ext.
AQ963013	4-Port FFABS	Tri-Axles	12V	3/8"	3/8"	3/8"	Spring Brake Priority, 3/4" Nipple
AQ963014	2-Port FFABS	Tandem Axles	12V	3/8"	3/8"	3/8"	Spring Brake Priority, 3/4" Nipple

# Haldex ABS (Anti-Lock Braking System) Valves (cont'd) +

## 2S/1M ABS RELAY VALVE KITS

### Multi-Axle Applications

- Competitive replacement
- For non-steer axles
- Cost effective solution for competitive system change-out
- ECU and ABS Valve designed to be serviced separately

AQ960514  
Shown



Service Part No.	Valve Type	Application	Voltage	Res. Port	Cont. Port	Del. Port	Kit Contents
AQ960503* WABCO	6-Port ABS Relay	Multi-Axle Kit	12V	1/2"	3/8"	3/8"	6.0M Power Cord Extension, 3.0M Sensor Extension
AQ960510* Bendix®	6-Port ABS Relay	Tandem Spring Suspension Kit	12V	1/2"	3/8"	3/8"	6.0M Power Cord Extension, 2.0M Sensor Extension
AQ960514* MBS WNC-MAX	4-Port ABS Relay	Tandem Air Ride Suspension Kit	12V	1/2"	3/8"	3/8"	Special Mounting Bracket, 6.0M Power Cord Extension, 2.5M Sensor Extension and Clips, Miscellaneous Hardware Required for Installation
AQ960515* MBS WNC-LITE	4-Port ABS Relay	Multi-Axle Kit	12V	1/2"	3/8"	3/8"	Special Mounting Bracket, 6.0M Power Cord Extension, 2.5M Sensor Extension and Clips, Miscellaneous Hardware Required for Installation

\*The 2S/1M ABS Relay Valve Kits shown above require a separate Spring Brake Control Valve such as Haldex N34031A/KN26120. AQ960514 and AQ960515 also require an additional Kit AQ15457 or AQ15458 to upgrade Wabash in-axle sensor design to conventional sensor and exciter design.

## 4S/2M ABS KITS

- Cost-effective solution for competitive system changeout
- ECU and ABS Valve are designed to be serviced separately

AQ963011  
Shown



Service Part No.	Valve Type	Application	Voltage	Res. Port	Cont. Port	Del. Port	Kit Contents
AQ963002	4-Port FFABS	Competitive Changeout	12V	3/8"	3/8"	3/8"	Spring Brake Priority, Dual Nipple 1/2" and 3/4", 2-Port Relay Valve, Cables and Accessories Included
AQ963011	2-Port FFABS	Competitive Changeout	12V	3/8"	3/8"	3/8"	Spring Brake Priority, Dual Nipple 1/2" and 3/4", 2-Port Relay Valve, Cables and Accessories Included

## ABS RELAY VALVE

### 2-Port and 6-Port Delivery

AL364040  
Shown



Service Part No.	Valve Type	Application	Voltage	Res. Port	Cont. Port	Del. Port	Notes
AL364040	2-Port ABS Relay	Single Axle 2S/1M or 4S/2M	12V	3/8"	3/8"	3/8"	1/2" Reservoir Mount
AL364045	2-Port ABS Relay	Single Axle 2S/1M or 4S/2M	12V	3/8"	3/8"	3/8"	1/2" Frame Mount
AL364080	2-Port ABS Relay	Single Axle 2S/1M or 4S/2M	12V	3/8"	3/8"	3/8"	1/2" Reservoir Mount
AL364041	6-Port ABS Relay	Multiple-Axle 2S/1M 3 or More Axles 4S/2M	12V	3/8"	3/8"	3/8"	1/2" Reservoir Mount
AL364046	6-Port ABS Relay	Multiple-Axle 2S/1M 3 or More Axles 4S/2M	12V	3/8"	3/8"	3/8"	1/2" Frame Mount

# Haldex ABS (Anti-Lock Braking System) Valves +

## FFABS VALVE

2-Port and 4-Port Delivery

AL430614  
Shown



Service Part No.	Valve Type	Application	Voltage	Res. Port	Cont. Port	Del. Port	Notes
AL430614	4-Port FFABS	Multiple-Axle 2S/1M 3 or More Axles 4S/2M	12V	3/8"	3/8"	3/8"	1/2" & 3/4" Nipple, Service Brake Priority
AL430620	4-Port FFABS	Multiple-Axle 2S/1M 3 or More Axles 4S/2M	24V	3/8"	3/8"	3/8"	1/2" & 3/4" Nipple, Service Brake Priority
AL430624	4-Port FFABS	Multiple-Axle 2S/1M 3 or More Axles 4S/2M	12V	3/8"	3/8"	3/8"	1/2" & 3/4" Nipple, Spring Brake Priority
AL430644	2-Port FFABS	Single Axle 2S/1M or 4S/2M	12V	3/8"	3/8"	3/8"	1/2" & 3/4" Nipple, Service Brake Priority
AL430664	2-Port FFABS	Single Axle 2S/1M or 4S/2M	12V	3/8"	3/8"	3/8"	1/2" & 3/4" Nipple, Spring Brake Priority
AL430666	4-Port FFABS	Multiple-Axle 2S/1M 3 or More Axles 4S/2M	12V	3/8"	3/8"	3/8"	1/2" & 3/4" Nipple, Spring Brake Priority
AL430668	4-Port FFABS	Multiple-Axle 2S/1M 3 or More Axles 4S/2M	12V	3/8"	3/8"	3/8"	1/2" & 3/4" Nipple, Service Brake Priority
AL430670	2-Port FFABS	Single Axle 2S/1M or 4S/2M	12V	3/8"	3/8"	3/8"	1/2" & 3/4" Nipple, Spring Brake Priority
AL430672	2-Port FFABS	Single Axle 2S/1M or 4S/2M	12V	3/8"	3/8"	3/8"	1/2" & 3/4" Nipple, Service Brake Priority

## SENSOR ACCESSORIES

Service Part No.	Description
A59512309	Sensor Block Retainer
A902700	Tractor/Trailer ABS Retainer
A920802	Sensor Block (Trailer)

## UNIVERSAL SENSOR EXTENSIONS

- ECU end has 2-Pin female connector
- Sensor end has 2-Pin male connector



Service Part No.	Description	Service Part No.	Description
AL919800	1.6 Feet (0.5m)	AL919806	11.5 Feet (3.5m)
AL919801	3.3 Feet (1m)	AL919807	13.1 Feet (4m)
AL919802	4.9 Feet (1.5m)	AL919808	16.4 Feet (5m)
AL919803	6.6 Feet (2m)	AL919809	19.7 Feet (6m)
AL919804	8.2 Feet (2.5m)	AL919810	26.2 Feet (8m)
AL919805	9.8 Feet (3m)	AL919811	32.8 Feet (10m)

## CAN CABLES FOR ITCM ABS

- Over molded 4 Pin Aux toAux
- Works with Haldex ITCM ECU



AL929832 Shown

Note: Required when using some Haldex auxiliary applications.

Service Part No.	Product Description	Cable Length	OEM Part No.
AL929827	CAN Cable, 4 pin	1.3 feet (6.5m)	814037001
AL929828	CAN Cable, 4 pin	1.6 feet (0.5m)	814037011
AL929829	CAN Cable, 4 pin	26.25 feet (8.0m)	814037021
AL929830	CAN Cable, 4 pin	45.9 feet (14.0m)	814037031
AL929831	CAN Cable, 4 pin	8.2 feet (2.5m)	814037041
AL929832	CAN Cable, 4 pin	3.3 feet (1.0m)	814037051
AL929833	CAN Cable, Y-Splitter (3 Female)	1.6 feet (0.5m) Each	814038001
AL929834	CAN Cable, y-Splitter (2 Female, 1 Male)	1.6 feet (0.5m) Each	814038101
AL929835	CAN Cable, ECU to side of vehicle (not pictured)	8.2 feet (2.5m)	814030011
AL929836	CAN Cable, Vehicle to PC (Dongle - not pictured)	21.3 feet (6.5m)	814011001

# Electronic Control Units (ECU) and Upgrade Kits

- Wheel speed sensor and Trailer power connects directly to ECU (no intermediate cables required)
- Single fastener design assures easy serviceability
- Potted ECU enclosure provides excellent protection from the environment



AL919338 Shown



AL919342 Shown



AQ964110 Shown

## PLC SELECT 1M ECU (2S/1M)

Service Part No.	Description	ECU Specifications	Application
AL919336	PLC Select Plus ECU	DIN 12V, SLH-A7	Multi-Axle
AL919338	PLC Select 1M ECU	DIN 12V, SLH-A7	Multi-Axle (Non-Steer Axles)
AL919339	PLC Select 1M ECU	DIN 12V, SLH-A8	Dollies and Single Axle
AL919340	PLC Select 1M ECU	DIN 12V, SLH-A7	Multi-Axle (Non-Steer Axles)
AL919341	PLC Select 1M ECU	DIN 12V, SLH-A8	Dollies and Single Axle

## ECU UPGRADE KITS (2S/1M)

Service Part No.	ECU Design	Kit Contents	Application
AQ960502	PLC Select A8	2.0m Power Cord Extension 3.0m Sensor Extensions PLC Select ECU & Bracket Power Cord End Kit	Dollies and Single Axle
AQ964110	PLC Select A7	1.0m Power Cord Extension 0.5m Sensor Extensions PLC Select ECU & Bracket	Tandem and Multiple Axles

## PLC SELECT 2M ECU (2S/2M and 4S/2M)

Service Part No.	Description	ECU Specifications	Application
AL919342	PLC Select 2M ECU	DIN 12V, SLH-A7	Multi-Axle

## ECU UPGRADE KITS (4S/2M)

Service Part No.	ECU Design	Kit Contents	Application
AQ964111	4S/2M ECU	2.0m Power Cord Extension 1.0m Sensor Extensions PLC Select 2M ECU & Bracket Power Cord End Kit Valve Relay Cable	Multi-Axle

# ABS Sensors

## SENSORS WITH RETAINER CLIP

- Sensors supplied with A59512309 Retainer Clip.
- Longer lengths may be used; secure excess to trailer

### Sensor - 90° Body - With Clip

Service Part No.	Description
AL10271914	1.6 Feet (0.5m)
AL364068	4.0 Feet (1.25m)
AL364061	4.9 Feet (1.5m)
AL364069	5.0 Feet (1.75m)
AL10271915	6.6 Feet (2m)
AL364070	7.0 Feet (2.25m)
AL364062	8.2 Feet (2.5m)
AL364071	9.0 Feet (3m)
AL364063	11.5 Feet (4m)
AL364053	13.1 Feet (4m)



### Sensor - 90° Body With Clip and Block

Service Part No.	Description
AQ40213	6.6 Feet (2m)

### Sensor - Straight Body With Clip

Service Part No.	Description
AL1027196	1.6 Feet (0.5m)
AL1027197	6.6 Feet (2m)
AL1027198	13.1 Feet (4m)

#### NOTES:

1. Sensors supplied with A59512309 Retainer Clip.
2. Longer lengths may be used. Secure excess to trailer.

## Meritor WABCO Style Remanufactured Trailer/Dolly Valves +

- ABS Valve and ECU Included
- Trailer and Dollie Applications  
Built After 3/01
- Exhaust Port - Not Threaded



4005001010KX  
4005001010X  
4005001040X



4005001020X  
400502030X



4005001010KX  
4005001010X  
4005001040X



4008506020X  
4721950330X



8946062752K

### 2S/1M Trailer ABS Assembly

Service Part No.	Application	Voltage	Control Port	Delivery Port	Supply Port	Notes
4005001010KX	Standard Trailers	12V	3/8 - 18	3/8 - 18	3/4 - 14	<b>89646062752K</b> Cable Included, Core Group: ABS20
4005001010X	Standard Trailers	12V	3/8 - 18	3/8 - 18	3/4 - 14	Core Group: ABS20
4005001040X	Turntables, Steerables and Dollies	12V	3/8 - 18	3/8 - 18	3/4 - 14	Core Group: ABS20

### 2S/2M Trailer ABS Assembly

Service Part No.	Application	Voltage	Control Port	Delivery Port	Supply Port	Notes
4005001020X	Standard Trailers	12V	1/4 - 18	3/8 - 18	3/4 - 14	Dual Modulator Valve, Core Group: ABS21

### 2S/2M-4S/2M-4S/3M Trailer ABS Assembly

Service Part No.	Application	Voltage	Control Port	Delivery Port	Supply Port	Notes
4005001030X	Multi-Configuration	12V	1/4 - 18	3/8 - 18	3/4 - 14	Dual Modulator Valve, Core Group: ABS21

### Valves/Valve Cable

Service Part No.	Application	Voltage	Control Port	Delivery Port	Supply Port	Notes
4008506020X	VALVE ONLY for 405001020X 405001030X	12V	1/4 - 18	3/8 - 18	3/4 - 14	Core Group: ABS23
4721950330X	VALVE ONLY 4005001010KX 4004001010X 4005001040X	12V	3/8 - 18	3/8 - 18	3/4 - 14	Core Group: ABS22
8946062752K	Modulator Valve Cable	-	-	-	-	Connects 1M ECU to Relay Valve, .5 Meter Length, Right Angle Valve Connector 1.65"

## Meritor WABCO Style Remanufactured ABS Truck Valves



4725001000X



4721950050X



4721950520X



9730110210X

Service Part No.	Description	Voltage	System Configuration	Modulator Valve Ports	Notes
4725001000X	Rear Axle Valve Pack	12V	4S/2M	1/2" - 14 NPT	Includes (1) 4721950800X Modulator Valve Right (1) 4721950810X Modulator Valve Left, (1) 9730110210X Relay Valve 4 PSI, Core Group: ABS5
4721950050X	Modulator Valve (Screw-In)	12V	One Delivery 180° from Supply	1/2" - 14 NPT	Core Group: ABS1
4721950520X	Modulator Valve (Bayonet)	12V	One Delivery 180° from Supply	1/2" - 14 NPT	Core Group: ABS1
9730110210X	Service Brake Relay Valve for Valve Pack	12V	4S/4M or 6S/4M	-	Crack Press: 4 PSI, Cont 1/4"-18NPTF, Sup 1/2"-14NPTF, Del 3/8"-18NPTF, Core Group: ABS11

## Meritor WABCO Style Remanufactured ABS Truck/Tractor/Bus Valves +

### MERITOR WABCO STYLE QUICK RELEASE VALVE FOR VALVE PACKS

- Front Axle ABS Valve Packs
- Each Individual Valve Includes: (2) O-Rings, (4) Mounting Bolts and Grease Pack
- Core Group: ABS12



Service Part No.	System Config.	Supply Port	Crack Pressure
9735001040X	All Steer Axle	1/2" - 14 NPTF	1 PSI
9735001050X	All Steer Axle	1/2" - 14 NPTF	3-4 PSI
9735001060X	All Steer Axle	1/2" - 14 NPTF	6-8 PSI

### MERITOR WABCO STYLE AUTOMATIC TRACTION CONTROL (ATC) VALVE PACK

- Rear Axle ABS Valve Packs
- Compatible with D&E versions of Meritor WABCO Style ECUs
- Core Group: ABS15

Service Part No.	Application	Voltage	Connector Type
4721707910X	ABS Rear Axle Valve Pack	12V	Screw-In
4721707970X	ABS Rear Axle Valve Pack	12V	Bayonet



Screw-In



Bayonet



### MERITOR WABCO STYLE CONVERTER CABLES



Service Part No.	Description
8946011322K	6" Bayonet to Screw-In Converter Cable

Service Part No.	Description
8946011332K	6" Screw-In to Bayonet Converter Cable



## Remanufactured Clutches - 13" +

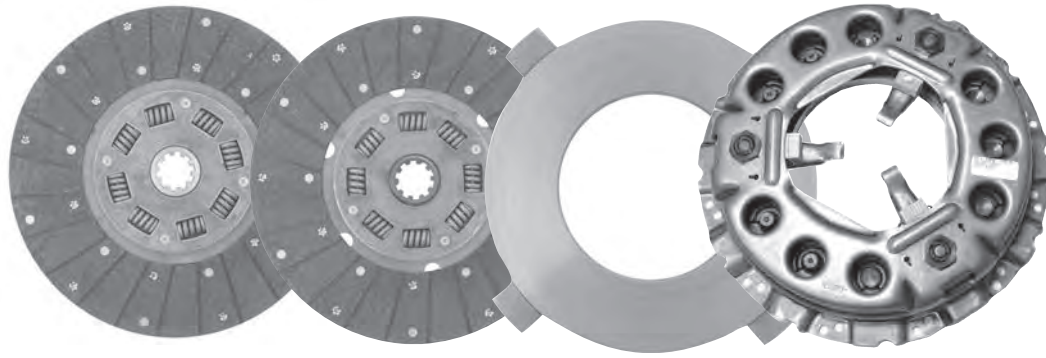

### LIPE PUSH TYPE CLUTCH - 13" SINGLE PLATE - FLAT FLYWHEEL

Reman Pack No.	Cover Assembly	Disc Assembly	Disc Type	Spline Size	Max Torque	Bolt Circle	Application
RC1933114X	RC3301933X	130-009-1802	DAMP ORGANIC	1.25" - 10T	350	14.125/14.625	NAVISTAR
RC1933117X	RC3301933X	130-009-1902	DAMP CERAMIC	1.25" - 10T	600	14.125/14.625	NAVISTAR
RC1933134X	RC3301933X	130-009-1135	DAMP ORGANIC	1.5" - 10T	350	14.125/14.625	PERKINS
RC1935136X	RC3301935X	330-009-1865	DAMP CERAMIC	1.5" - 10T	500	375mm/14.764	RENAULT
RC1938124X	RC3301938X	130-009-1803	DAMP ORGANIC	1.38" - 10T	350	14.125/14.625	FORD /DODGE
RC1938127X	RC3301938X	130-009-1903	DAMP CERAMIC	1.38" - 10T	350	14.125/14.625	FORD/DODGE
RC1938134X	RC3301938X	130-009-1135	DAMP ORGANIC	1.5" - 10T	350	14.125/14.625	CHEV/GMC
RC1938137X	RC3301938X	130-009-1904	DAMP CERAMIC	1.5" - 10T	500	14.125/14.625	CHEV/GMC
RC2077136X	RC3302077X	330-009-2078	DAMP CERAMIC	1.5" - 10T	500	14.125/14.625	CAT 3116/3126 ENG.

### LIPE PUSH TYPE CLUTCH - 13" TWO PLATE - 1.062 RECESS FLYWHEEL

Reman Pack No.	Cover Assembly	Disc Assembly	Disc Type	Inter. Plate	Spline Size	Max Torq.	Bolt Circle	Application
RC1931134X	RC3301931X	130-009-1134 FWS 130-009-1135 PPS	DAMP ORG	C025-0094	1.5" - 10T	350	14.125/14.625	CUMMINS
RC1931144X	RC3301931X	130-009-1136 FWS 130-009-1137 PPS	DAMP ORG	C025-0094	1.75" - 10T	600	14.125/14.625	CUMMINS
RC1937134X	RC3301937X	130-009-1134 FWS 130-009-1135 PPS	DAMP ORG	C025-0094	1.5" - 10T	600	14.125/14.625	CHEV/GMC, CUMMINS
RC1989134X	RC3301989X	130-009-1134 FWS 130-009-1135 PPS	DAMP ORG	C025-0094	1.5" - 10T	600	14.125/14.625	NAVISTAR, FORD
RC1989138X	RC3301989X	130-009-1530 FWS 130-009-1531 PPS	DAMP CER	C025-0094	1.5" - 10T	750	14.125/14.625	NAVISTAR, FORD

### LIPE PUSH TYPE CLUTCH - 13" TWO PLATE - 1.478 RECESS FLYWHEEL

Reman Pack No.	Cover Assembly	Disc Assembly	Disc Type	Inter. Plate	Spline Size	Max Torq.	Bolt Circle	Application
RC1940132X	RC3301940X	130-006-1830	RIGID ORG	C025-0096	1.5" - 10T	-	-	FORD GAS
RC1940136X	RC3301940X	130-009-1530 FWS 130-009-1531 PPS	DAMP CER	C025-0096	1.5" - 10T	-	-	FORD GAS
RC1941134X	RC3301941X	130-009-1134 FWS 130-009-1135 PPS	DAMP ORG	C025-0094	1.5" - 10T	600	14.500	CAT 3208

## Remanufactured Clutches - 14" +

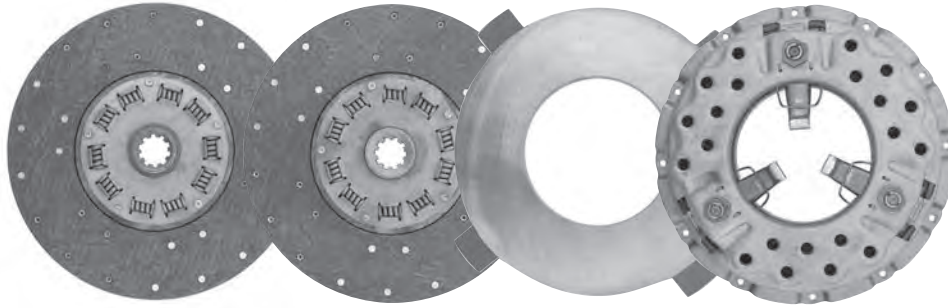

### LIPE PUSH TYPE CLUTCH - 14" SINGLE PLATE - FLAT FLYWHEEL

Reman Pack No.	Cover Assembly	Disc Assembly	Disc Type	Spline Size	Max Torque	Bolt Circle	Application
RC1047604X	RC141047X	140-009-1027	DAMP ORGANIC	1.5" - 10T	500	15.500	CHEV/GMC /FORD
RC1086604X	RC141086X	140-009-1027	DAMP ORGANIC	1.5" - 10T	500	15.500	NAVISTAR
RC1686607X	RC141686X	140-009-2208	DAMP CERAMIC	1.5" - 10T	500	15.500	CHEV/GMC DIESEL
RC1686640X	RC141686X	140-009-1998	DAMP CERAMIC	1.5" - 10T	500	15.500	CHEV/GMC GAS

### LIPE PUSH TYPE CLUTCH - 14" TWO PLATE - 1.062 RECESS FLYWHEEL

Reman Pack No.	Cover Assembly	Disc Assembly	Disc Type	Inter. Plate	Spline Size	Max Torq.	Bolt Circle	Application
RC1072604X	RC141072X	140-009-2355 FWS 140-009-2356 PPS	DAMP ORG	C025-0100	1.5" - 10T	600	15.500	FORD
RC1072607X	RC141072X	140-009-2357 FWS 140-009-2208 PPS	DAMP CER	C025-0100	1.5" - 10T	900	15.500	FORD

### LIPE PUSH TYPE CLUTCH - 14" TWO PLATE - 1.093 RECESS FLYWHEEL

Reman Pack No.	Cover Assembly	Disc Assembly	Disc Type	Inter. Plate	Spline Size	Max Torq.	Bolt Circle	Application
RC1067645X	RC141067X	140-009-2303 FWS 140-009-2304 PPS	DAMP ORG	C025-0100	1.75" - 10T	1000	15.625	VARIOUS CRANE
RC1067646X	RC141067X	140-009-2299 FWS 140-009-2300 PPS	DAMP CER	C025-0100	1.75" - 10T	1200	15.625	VARIOUS CRANE
RC1113604X	RC141113X	140-009-2212 FWS 140-009-2213 PPS	DAMP ORG	C025-0100	1.75" - 10T	750	15.500	CHEV/GMC
RC1113606X	RC141067X	140-009-2210 FWS 140-009-2211 PPS	DAMP CER	C025-0100	1.75" - 10T	1000	15.500	CHEV/GMC
RC1113649X	RC141113X	140-009-2303 FWS 140-009-2304 PPS	DAMP ORG	C025-0100	1.75" - 10T	750	15.500	CATERPILLAR

NOTE: Replacement Disc Assemblies Available in New Only. Rigid Discs Not Recommended.

## New/Remanufactured Clutches - 14" & 15 1/2" +



### SPICER TYPE CLUTCH PACK - 14" TWO PLATE - RECESS FLYWHEEL

New Pack No.	Reman Pack No.	Disc Type	Spline Size	Weight	Application
HN10803482	RC390DOX	DAMP ORGANIC	2" - 10T	105 lbs.	VARIOUS
HN10805059	RC390DCX	DAMP CERAMIC	2" - 10T	103 lbs.	VARIOUS



### EATON 15 1/2" EZ-PEDAL™ CLUTCH PACK

New Pack No.	Reman Pack No.	Disc Type	Spline Size	Weight	Application
HN10839174	RC018EZX	10 SPRING CERAMIC	2" - 10T	143 lbs.	CAT 3406B, DDC 60 SERIES, EARLY MACK
HN10839181	RC597DCX	DAMP CERAMIC	2" - 10T	137 lbs.	VARIOUS
HN10839182	RC597DOX	DAMP ORGANIC	2" - 10T	139 lbs.	VARIOUS
HN10892582	RC700EZX	7 SPRING CERAMIC	2" - 10T	142 lbs.	CUMMINS N-14
HN10893551	RC698EZX	9 SPRING CERAMIC	2" - 10T	146 lbs.	LATE MACK E6-E7

Haldex offers a complete line of New and Remanufactured Clutches. Please consult the Haldex Master Catalog ([haldex.com](http://haldex.com)) for our complete listing.

## Midland Flywheels +

Midland Flywheels are manufactured to meet and exceed OEM specifications and are competitively priced to deliver economy and uptime advantages to your fleet

- Utilize maximum adjustment capacity of clutch
- No need for thick clutch brake or spacers
- Eliminates cost of turning flywheel
- Speeds up install by eliminating machining time
- Guaranteed flat, smooth, free of scoring and heat marks to reduce warranty cost / increase clutch life
- Release bearing travel is returned to OE specs
- Warranted for 1 year or 100,000 miles

# MIDLAND™



Midland Part No.	Reference Number	Application
FW1265875	1265875	CATERPILLAR 3116 / 3126
FW9Y9311	9Y9311 / 9L6392	CATERPILLAR 3208
FW4P4797	4P4797	CATERPILLAR 3406 / 3406E
FW2569653	2569653	CATERPILLAR C15,C16,C18
FW3921263	3921263	CUMMINS 5.9L B Series
FW3016495	3016495	CUMMINS NT855
FW3071535	3021660 / 3071535	CUMMINS 855 / N14
FW3680922	3680922	CUMMINS ISX SIGNATURE 600
FW3042787	3042787	CUMMINS L10 / M11
FW3071615	3039230 / 3071615	CUMMINS L10 / M11
FW23509709	23507442 / 23509709	DETROIT 60 Series
FW1818214C91	1818214C91	IHC 7.3 444E
FW1810855C93	1810855C93	IHC DT466
FW1821915C91	1821915C91	IHC DT466E
FW530GB3170	530GB3170	MACK TECH-E7 SRS

## Midland Pilot Bearings +

Midland Pilot Bearings meet and beat OEM specifications and industry standards for high-temperature performance.

- C3 clearance specification recommended by Eaton allows optimal expansion from heat and improper alignment to ensure durability and performance
- Nitrile seals – most widely used and most cost effective
- Viton® seals for the higher temperatures produced by today's high torque engines
- Steel shielded for lower operating temperatures

# MIDLAND™



Type	Seal/Shield Description
2RS	Nitrile Seal
2RSV	Viton® Seal
2RSV-S	Viton Seal (includes snap ring for Mack engines)
ZZ	Steel Shield
ZZ-S	Steel Shield (includes snap ring for Mack engines)

Midland Part No.	Reference Number	Outside Diameter	Inside Diameter	Width	Seal/Shield Description
PB6005-2RS	105CC	1.85"	0.99"	0.47"	Nitrile Seal
PB6005-ZZ	105ZZ	1.85"	0.99"	0.47"	Steel Shield
PB6203-2RS	203FF	1.58"	0.67"	0.47"	Nitrile Seal
PB6205-2RSV	205FF	2.05"	0.99"	0.59"	Viton® Seal
PB6304-ZZ	304SS	2.05"	0.79"	0.59"	Steel Shield
PB6305-2RS	305FF	2.45"	0.99"	0.67"	Nitrile Seal
PB6306-2RS	306FF	2.84"	1.18"	0.75"	Nitrile Seal
PB6306-2RSV	306FF	2.84"	1.18"	0.75"	Viton Seal
PB6306-2RSV-S	306FFL	2.84"	1.18"	0.75"	Viton Seal w/snap ring (Mack application)
PB6306-ZZ	306SS	2.84"	1.18"	0.75"	Steel Shield
PB6306-ZZ-S	306SSL	2.84"	1.18"	0.75"	Steel Shield w/snap ring (Mack application)

Viton® is a registered trademark of DuPont Performance Elastomers

**Haldex offers a complete line of Midland Flywheels and Pilot Bearings. Please consult the Haldex Master Catalog ([haldex.com](http://haldex.com)) for our complete listing.**

Most Haldex Remanufactured Parts are also available in New and CoreFree .  
Please consult the Haldex Master Catalog (haldex.com) for our complete listing. +

## Remanufactured Alternators

RA121000X  
RA122001X



### REMANUFACTURED DELCO ALTERNATORS

Service Part No.	Type	Voltage	AMPS	Polarity	DELCO Reman No.
RA121000X	21-SI	12V	100	Negative	10459013
RA122001X	22-SI	12V	130	Negative	10459189

RA228000X



### REMANUFACTURED LEECE-NEVILLE ALTERNATORS

Service Part No.	Type	Voltage	AMPS	Polarity	DELCO Reman No.
RA228000X	JB Series	14V	160	Positive/Negative	2800JB

RA403000X



### REMANUFACTURED MOTOROLA ALTERNATORS

Service Part No.	Type	Voltage	AMPS	Polarity	MOTOROLA Reman No.
RA403000X	10-255 & 10-555	12V	130	Insulated (Pos./Neg. Ground)	8LHA2023V

## Remanufactured Delco Starters



RS140001X



RS142001X

Service Part No.	Type	Voltage	Rotation	Pinion Teeth	Switch Position	DELCO Reman No.
RS137000X	37-MT	12V	CW	12	068°	10461089
RS140001X	40-MT	12V	CW	11	052°	10461045
RS142001X	42-MT	12V	CW	11	082°	10461052
RS142002X	42-MT	12V	CW	12	082°	10461414

Most Haldex Remanufactured Parts are also available in New and CoreFree .  
Please consult the Haldex Master Catalog (haldex.com) for our complete listing. +

## Remanufactured Lucas Girling Hydraulic Brake Calipers



### BENDIX® 2.88" TWIN PISTON - CHEV/GMC/NAVISTAR

Service Part No. Caliper Only	Service Part No. Loaded Kit	Service Part No. Semi-Loaded Kit	Casting Number	Shim Kit	Service Part No. Hardware Kit
RH55250X	RH55250LLX (left) RH55250RLX (right)	RH55250SX	4150844	SK225K	RH5635K



### DAYTON 2.50" TWIN PISTON - CHEV/GMC/FORD

Service Part No. Caliper Only	Service Part No. Loaded Kit	Service Part No. Semi-Loaded Kit	Casting Number	Shim Kit	Service Part No. Hardware Kit
RH55251X	RH5525LX	RH55251SX	472	SK224K	RH5636K



### BENDIX® 2.60" TWIN PISTON - NAVISTAR

Service Part No. Caliper Only	Service Part No. Loaded Kit	Service Part No. Semi-Loaded Kit	Casting Number	Shim Kit	Service Part No. Hardware Kit
RH55314X	RH5314LX	RH55314SX	4151733	SK224K	RH5634K



REMANUFACTURED IN THE USA



Most Haldex Remanufactured Parts are also available in New and CoreFree .  
Please consult the Haldex Master Catalog ([haldex.com](http://haldex.com)) for our complete listing. +

## Air Control Valves



**Sprague Compatible**  
Service  
Part No.  
RM1115001



**Trico Compatible**  
Service  
Part No.  
RM1650001

## Air Wiper Motors

Service  
Part No.  
RM2598001X

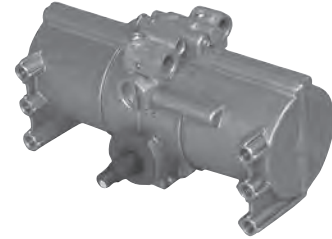

Service  
Part No.  
RM3495001X



## Remanufactured Haldex/Competitive Master Cylinders and Vacuum Boosters

### BENDIX® VACUUM BOOSTER

Service  
Part No.  
RV2503259X

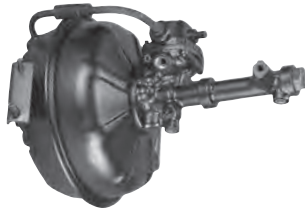

### Midland Master Cylinder

Service  
Part No.  
RV350002X



## All Makes Remanufactured Steering Gears & Pumps

- For Caterpillar, Cummins, Detroit Diesel, Ford, General Motors, Mack, Navistar and Thermo-King Engines

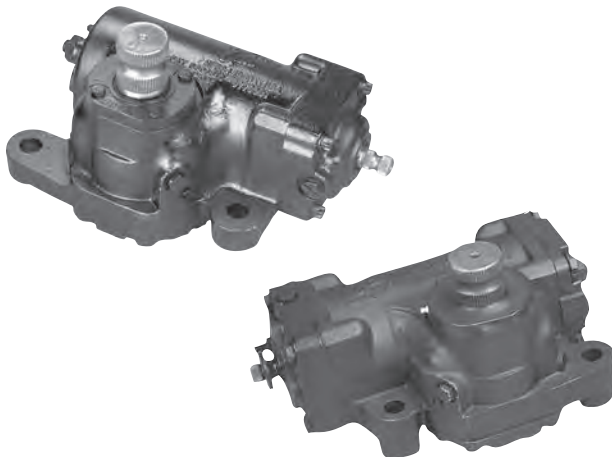

- Haldex offers TRW, Saginaw, Hobourn/Eaton and Vickers

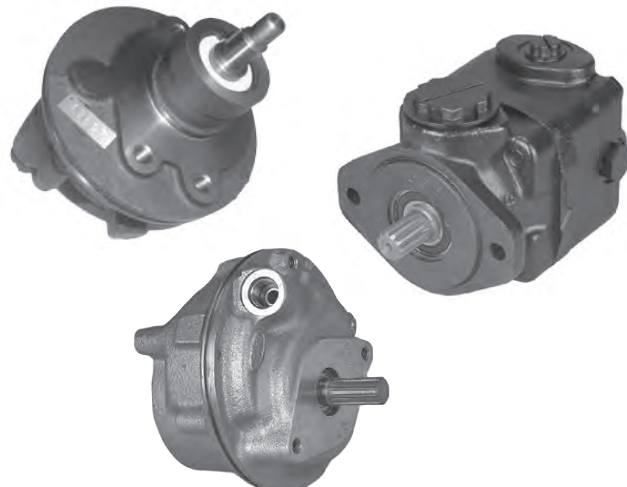



# Midland Air Brake Disc Pad Replacement Kits +

## PRODUCT OFFERING



Each replacement kit includes four disc pads and the hardware necessary to complete one axle.

### HD PRO Air Disc Brake Pads

 MAXIMUM, HEAVY-DUTY FRICTION

Developed for transit, refuse, dump, coach – high frequency – extreme temperature braking

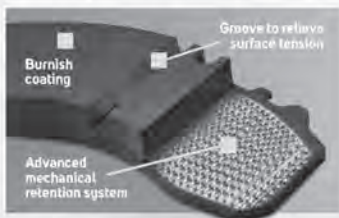

- Quiet, safe, reliable
- Exceptional fade and recovery in demanding stop-and-go and variable, high-load applications
- Outstanding durability with long life formulation
- Rotor friendly friction compound
- Full surface burnish coating
- V Groove noise and wear reduction design
- Advanced mechanical retention system
- FMVSS 121 & ECE R90 certified



### CV advanced Air Disc Brake Pads

 PREMIUM, MID/HEAVY-DUTY FRICTION

Developed for trucks, tractors, trailers, dump, coach – coast-to-coast operations – standard & heavy haul loads

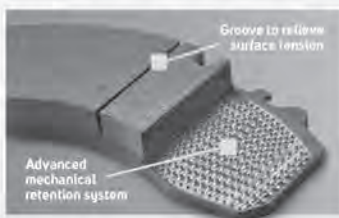

- Quiet friction compound
- Excellent fade resistance and recovery at moderate-to-high braking temperatures
- Long life, proven wear performance
- Solid durability and rotor friendly
- Advanced mechanical retention system
- FMVSS 121 & ECE R90 certified



### SELECT XT Air Disc Brake Pads

 STANDARD-DUTY FRICTION

Developed for trucks, tractors, trailers – interstate & urban – standard line haul loads

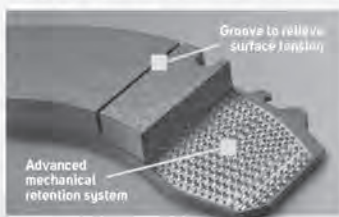

- High value cost benefit ratio
- Reliable, stable performance
- Slotted for vibration and noise reduction properties
- Corrosion resistant coating
- Easy on rotors
- Advanced mechanical retention system
- FMVSS 121 & ECE R90 certified



# Midland Air Brake Disc Pads (cont'd) +

## AIR BRAKE DISC PAD IDENTIFICATION

## ◆ POPULAR FMSI NUMBER

**BRAKE MFR & SYSTEM:** Bendix® ADB22X™, Knorr SK7

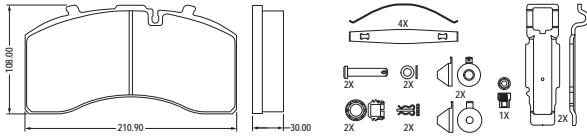

**APPLICATION:** Various  
**FMSI:** 8479 **D1369** ◆

**BRAKE MFR & SYSTEM:** Knorr SB7 & SN7

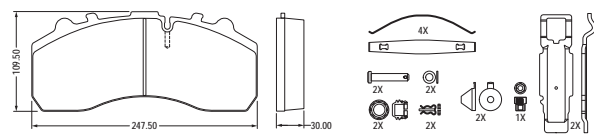

**APPLICATION:** Neoplan, Nova, Prevost®, Setra, Van Hool  
**FMSI:** 8323 **D1203** ◆

**BRAKE MFR & SYSTEM:** Hendrickson® MAXX22T™

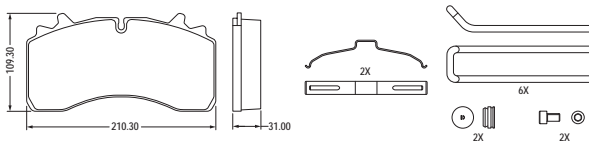

**APPLICATION:** Hendrickson®  
**FMSI:** 9007 **D1777**

**BRAKE MFR & SYSTEM:** Meritor® EX225H2

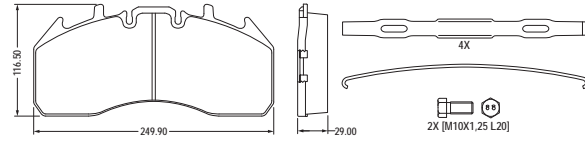

**APPLICATION:** MCI  
**FMSI:** 8426 **D1311** ◆

**BRAKE MFR & SYSTEM:** Meritor® D-ELSA2

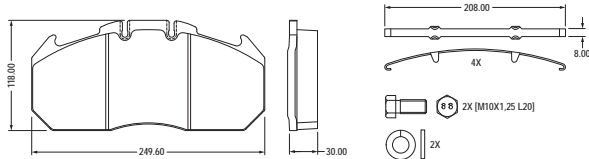

**APPLICATION:** MAN®, Van Hool  
**FMSI:** 8425 **D1310**

**BRAKE MFR & SYSTEM:** Meritor® EX225L2

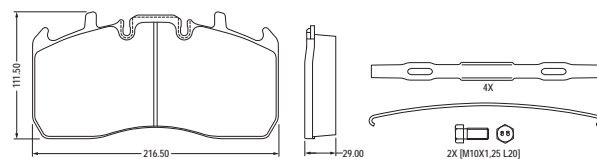

**APPLICATION:** Various  
**FMSI:** 8480 **D1370**

**BRAKE MFR & SYSTEM:** Meritor® D-DUCO

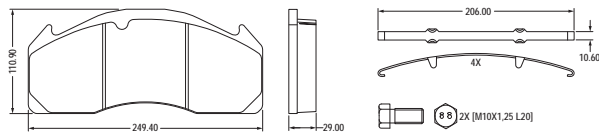

**APPLICATION:** Volvo  
**FMSI:** 8771 **D1560**

**BRAKE MFR & SYSTEM:** Meritor® EX2252H2

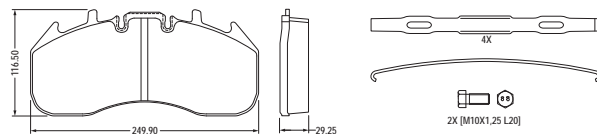

**APPLICATION:** MCI  
**FMSI:** 8917 **D1690**

**BRAKE MFR & SYSTEM:** WABCO PAN™ 22

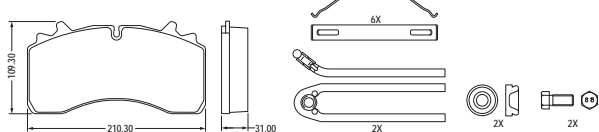

**APPLICATION:** SAF Axles  
**FMSI:** 9007 **D1777**

**BRAKE MFR & SYSTEM:** WABCO PAN™ 19-1

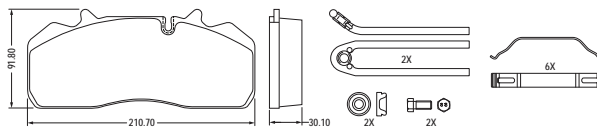

**APPLICATION:** SAF Axles  
**FMSI:** 8556 **D1438**

# Midland Air Brake Disc Pads (cont'd) +

## AIR BRAKE DISC PAD IDENTIFICATION

## ◆ POPULAR FMSI NUMBER

**BRAKE MFR & SYSTEM:** Haldex DB22, Spicer® ESD225™

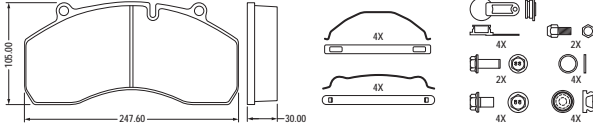

**APPLICATION:** SAF Axles, SMB Axles  
**FMSI:** 8577 **D1441**

**BRAKE MFR & SYSTEM:** Haldex DB22

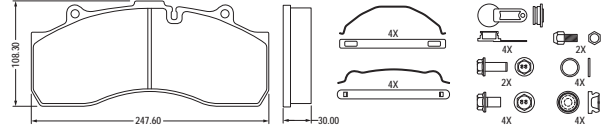

**APPLICATION:** SAF Axles, SMB Axles, Scania  
**FMSI:** 8735 **D1527**

**BRAKE MFR & SYSTEM:** Meritor® D-LISA

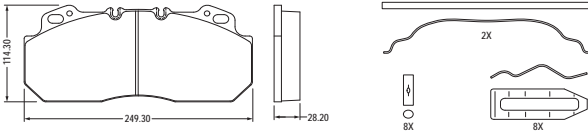

**APPLICATION:** MCI, Neoplan, Prevost®, Volvo  
**FMSI:** 8427 **D1312** ◆

**BRAKE MFR & SYSTEM:** Meritor® EX225H3

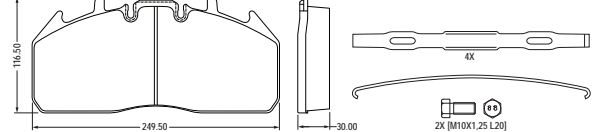

**APPLICATION:** Various  
**FMSI:** 8435 **D1323**

**BRAKE MFR & SYSTEM:** Meritor® D-ELSA1

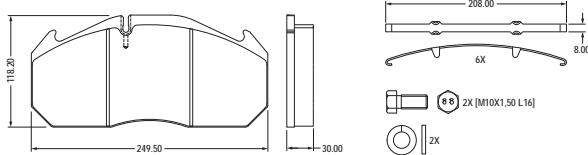

**APPLICATION:** MAN, Setra, Van Hool  
**FMSI:** 8515 **D1407**

**BRAKE MFR & SYSTEM:** Meritor® DX195

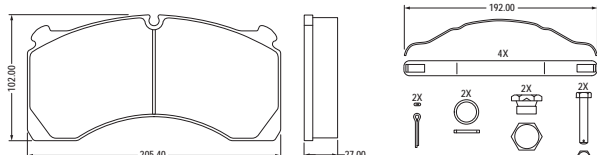

**APPLICATION:** Trailer Axles  
**FMSI:** 8733 **D1525**

**BRAKE MFR & SYSTEM:** Meritor® ELSA 225-3

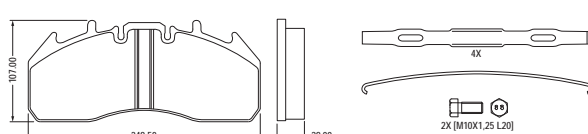

**APPLICATION:** Volvo  
**FMSI:** 8931 **D1708**

**BRAKE MFR & SYSTEM:** WABCO Maxxus™

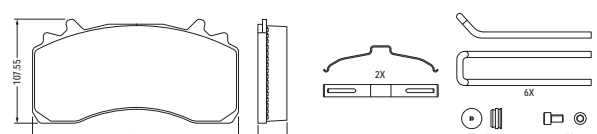

**APPLICATION:** Freightliner®, Western Star®  
**FMSI:** 9294 **D2061**

**BRAKE MFR & SYSTEM:** WABCO PAN™ 19-2

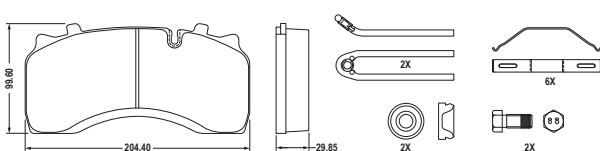

**APPLICATION:** SAF Axles  
**FMSI:** 8726 **D1517**

**BRAKE MFR & SYSTEM:** WABCO PAN™ 17

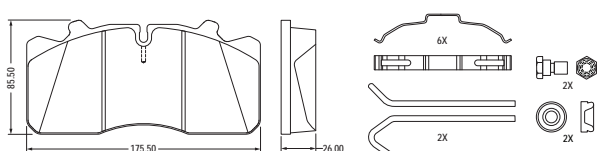

**APPLICATION:** Cozad® Trailers, Mack®  
**FMSI:** 8727 **D1518**

# Midland Air Brake Disc Pads (cont'd) +

## AIR BRAKE DISC PAD IDENTIFICATION

## ◆ POPULAR FMSI NUMBER

<b>HD PRO</b> PART NUMBERS EXTREME TEMPERATURE PERFORMANCE Heavy / Severe-Duty Cycles	<b>CV advanced</b> PART NUMBERS HIGH TEMPERATURE PERFORMANCE Moderate / Heavy-Duty Cycle	<b>SELECT XT</b> PART NUMBERS INTERSTATE LINEHAUL Standard / Moderate-Duty Cycle
MPBD1369HD	MPBD1369CV	MPBD1369XT
MPBD1203HD	MPBD1203CV	MPBD1203XT
MPBD1441HD	MPBD1441CV	MPBD1441XT
MPBD1527HD	MPBD1527CV	MPBD1527XT
MPBDH1777HD	MPBDH1777CV	N/A
MPBD1311HD	MPBD1311CV	MPBD1311XT
MPBD1312HD	MPBD1312CV	MPBD1312XT
MPBD1323HD	MPBD1323CV	MPBD1323XT
MPBD1310HD	MPBD1310CV	MPBD1310XT
MPBD1370HD	MPBD1370CV	MPBD1370XT
MPBD1407HD	MPBD1407CV	MPBD1407XT
MPBD1525HD	MPBD1525CV	MPBD1525XT
MPBD1560HD	MPBD1560CV	MPBD1560XT
MPBD1690HD	MPBD1690CV	MPBD1690XT
MPBD1708HD	MPBD1708CV	MPBD1708XT
MPBD2061HD	MPBD2061CV	MPBD2061XT
MPBD1777HD	MPBD1777CV	MPBD1777XT
MPBD1438HD	MPBD1438CV	MPBD1438XT
N/A	MPBD1517CV	N/A
MPBD1518HD	MPBD1518CV	MPBD1518XT

# Midland Air Brake Disc Pads (cont'd) +

## AIR BRAKE DISC PAD IDENTIFICATION

## ◆ POPULAR FMSI NUMBER

BRAKE MFR & SYSTEM	MAIN APPLICATION	FMSI NUMBER	OE PART NUMBER
Bendix® ADB22X, Knorr SK7	Various	8479 <b>D1369</b> ◆	Mercedes Benz # 004 420 70 20 SAF # 3057008500
Knorr® SB7 & SN7	Neoplan, Nova, Prevost®, Setra, Van Hool	8323 <b>D1203</b> ◆	MAN # 81508205099, 81508206030, 81508206032, 81508206056 Neoplan # 0821.340.00, 0821.351.00 SAF # 3057007700, 3057007900, 5317002300 Setra # 8285000571, 8285515573, 9291037 SMB # M100669
Haldex DB22, Spicer® ESD225	SAF Axles, SMB Axles	8577 <b>D1441</b>	Fruehauf® # M910027-03 Haldex # 790-22012 Bendix® # 976003N SAF # 81163, 87407
Haldex DB22	SAF Axles, SMB Axles, Scania	8735 <b>D1527</b>	Haldex # 91567, 790-22008
Hendrickson® MAXX22T™	Hendrickson®	9007 <b>D1777</b>	S-35303-1, 640 222 927 2
Meritor® EX225H2	MCL	8426 <b>D1311</b> ◆	Meritor® # 3222-F-2476
Meritor® D-LISA	MCL, Neoplan, Prevost®, Volvo	8427 <b>D1312</b> ◆	Volvo # 3093919, 3093939, 8550611, 20825594, 20850194, 85105485, 85506111
Meritor® EX225H3	Various	8435 <b>D1323</b>	Meritor® # KIT2252H3CE, KIT2252H3BE
Meritor® D-ELSA2	MAN, Van Hool	8425 <b>D1310</b>	Meritor® # 68324558, 68324957, 68325344, 68325346, 68325901, 68326015 Volvo # 20976509, 21309468, 85107768 Rockwell # 15227419T, 68324558N2P
Meritor® EX225L2	Various	8480 <b>D1370</b>	Meritor® # KIT2252L2CD
Meritor® D-ELSA1	MAN, Setra, Van Hool	8515 <b>D1407</b>	MAN # 81508205091, 81508206044, 81508206046 Meritor® # 68325023, 68325166 Setra # 8 285 388 435
Meritor® DX195	Trailer Axles	8733 <b>D1525</b>	Meritor® # 3222-T-2308, MDP1314, MDP5076, 15224835, 15224835A Rockwell # 15224835T400
Meritor® D-DUCO	Volvo	8771 <b>D1560</b>	Meritor® # MDP5057 Volvo # 1078439, 20768092, 20918891, 20931343, 20932682, 3095396
Meritor® EX225H2	MCL	8917 <b>D1690</b>	MCL # 04-01-1164 Meritor® # 3222-E-2605, KIT2252H2BA
Meritor® ELSA 225-3	Volvo	8931 <b>D1708</b>	Volvo # 20568711, 20568714, 21024701, 21024702, 21496550
WABCO Maxxus™	Freighliner® Western Star®	9294 <b>D2061</b>	640 322 934 2
WABCO PAN™ 22	SAF Axles	9007 <b>D1777</b>	SAF # 0233501309, 233501309, 3057008401, 3057008400 WABCO # 12999796
WABCO PAN™ 19-1	SAF Axles	8556 <b>D1438</b>	SAF # 3057008000
WABCO PAN™ 19-2	SAF Axles	8726 <b>D1517</b>	WABCO # 12999747VT
WABCO PAN™ 17	Cozad® Trailers, Mack®	8727 <b>D1518</b>	Mack® # 2611-12999703VT



Each replacement kit includes four disc pads and the hardware necessary to complete one axle.

# Haldex RSD Friction Products

## RSD Fleet Solutions



Haldex

## Reduced Stopping Distance Regulations

In July of 2009, the National Highway Traffic Safety Administration (NHTSA) issued an amendment to FMVSS No.121 relative to stopping distances to be implemented in two phases:

Reduced Stopping Distances Phase I & II						
Date of Implementation	Vehicle Type	Tractor GVWR (lbs.)	New Distance Unloaded	New Distance Loaded	Old Distance Unloaded	Old Distance Loaded
August 1, 2011	3 Axle Tractor	Up to 59,600	235 ft.	250 ft.	335 ft.	355 ft.
	3 Axle Tractor	59,600 – 70,000	235 ft.	250 ft.	335 ft.	355 ft.
	3 Axle Tractor	Above 70,000	235 ft.	310 ft.	335 ft.	355 ft.
August 1, 2013	2 Axle Tractor	Inclusive	235 ft.	250 ft.	335 ft.	355 ft.
	4+ Axle Tractor	Up to 85,000	235 ft.	250 ft.	335 ft.	355 ft.
	4+ Axle Tractor	Above 85,000	235 ft.	310 ft.	335 ft.	355 ft.
	4+ Axle Tractor	Above 85,000	235 ft.	310 ft.	335 ft.	355 ft.

## Safety first at Haldex

Safety has always been a core focus for Haldex. NHTSA's continuing mission of increasing safety on today's roadways is an effort Haldex is proud to support at many levels throughout the heavy-duty industry.

## Haldex friction products and FMVSS 121 RSD Performance Requirements

- GG 2020 and GR 2015 brake linings have been certified to comply with FMVSS 121 RSD performance requirements and testing protocols.
- RSD performance validation through on-vehicle testing was conducted on behalf of Haldex by LINK Commercial Vehicle Testing at TRC (Transportation Research Center, Inc.).

## FMVSS 121 dynamometer performance requirements

All Haldex friction materials satisfy the retardation, brake power and recovery specifications of NHSTA FMVSS 121 to assure compliance within this requirement regardless of the vehicle manufacturer and/or vehicle configuration.

**RSD** CERTIFIED  
GG 2020 • GR 2015

## Engineered stability

The high-performance legacy of Grey-Rock brake linings is built on decades of providing best-in-class stability.

Advanced friction compounds deliver highly stable brake linings that help you manage the rigors of variable load and road environments and the ever-growing demands for both safety and economy.

**GG 2020**  
Premium  
RSD Certified  
23,000 lb. axle



**GR 2015**  
Premium  
RSD Certified  
20,000 lb. axle



## The right choice

Brake linings should always be chosen based on the unique application environment **YOU** operate in.

Don't sacrifice brake performance – or your ROI – to a choice someone else made for you. Exercise your right to choose and upgrade to a high-performance aftermarket option.



# Haldex RSD Friction Products (cont'd)

## Reduced Stopping Distance FAQ



Fleets should take the time to ensure they understand the factors that affect safe braking performance, especially on vehicles that have been in service for a period beyond a year. Stopping performance on these "utilized" vehicles is typically reduced over time. The natural course of wear on wheel end and brake system components – as well as maintenance practices and driver braking habits – commonly result in decreased stopping performance.



### Fleets often ask these questions:

***Does the original brake lining supplied by the OEM have to be used for aftermarket replacement?***

**NO.**

***Are there aftermarket brake linings that are certified to meet FMVSS 121 reduced stopping distances?***

**YES.** For example Haldex GG 2020 and GR 2015 have been certified according to FMVSS 121 criteria.

***What are the requirements for linings used to service vehicles manufactured under this new rule?***

There are currently no federal motor carrier safety regulations governing aftermarket friction material or performance requirements, thus end users (fleets) are not required to verify that vehicles meet the new FMVSS 121 stopping distance requirements.

Once in the field, trucks and tractors are subject to a 20 mph stopping distance requirement under Federal Motor Carrier Safety Regulation (CFR 49 393), or an alternative brake retardation force requirement measured by a device known as a "Performance Based Brake Tester." These requirements are not new and will not change with the new stopping distance rule.

***Will the new ruling require a radical redesign of braking systems on Class 8 tractors?***

**NO.** There are no specific design requirements. New vehicles must meet Reduced Stopping Distance requirements, while still complying with all other existing performance requirements (FMVSS 121, etc.). OEMs may choose a variety of methods to increase braking force. Foundation brake enhancements could include:

- Increased brake drum diameter on the front axle
- Wider brake shoes (front and rear)
- Increased brake chamber size
- Longer brake adjuster arm
- More robust S-cam bushings
- Brake linings with increased coefficient of friction
- Re-enforcement of other components to reduce deflection



OEMs may also choose to direct more air pressure to the front axle brakes, taking advantage of their increased capacity. In most cases, a combination of these methods will be utilized to meet the requirements. OEMs may also offer air disc brakes as an option to increase performance.

***Will Haldex friction products qualify as acceptable replacement linings on vehicles manufactured under this new rule?***

**YES.** Tractor manufacturers will likely choose to incorporate a combination of enhancements to produce more "brake power" during stopping to achieve the required distances. Some may choose to utilize brake lining material with higher coefficient of friction as part of the solution. In many cases, using Haldex friction in place of the OEM friction material yields a variety of performance enhancements including reduced lining wear, less brake fade and increased brake power.

For all your friction needs, specify Haldex.

Contact your Haldex sales professional.

United States 816-891-2470  
Canada 519-621-6722  
Mexico 52-81-81569500

For additional contact information or to learn more about Haldex, please visit [haldex.com](http://haldex.com)

LF20758  
US 3/18 2.5M ALP  
Printed in the USA

# Grey-Rock Friction Products

**Grey-Rock**

## GM BRAKE BLOCK

Friction Code . . . . . FF  
 Material Type . . . . . 2040 Semi-Metallic  
 Brake Type . . . . . "S" Cam  
 GAWR . . . . . 25,000 lbs.

## GP BRAKE BLOCK

Friction Code . . . . . GG  
 Material Type . . . . . 2030 Organic  
 Brake Type . . . . . "S" Cam  
 GAWR . . . . . 26,000 lbs.

## GC BRAKE BLOCK

Friction Code . . . . . FF/FF  
 Material Type . . . . . GG/GZ Semi-Metallic/Organic Combo  
 Brake Type . . . . . "S" Cam  
 GAWR . . . . . 23,000 lbs.

## GZ BRAKE BLOCK

Friction Code . . . . . FF  
 Material Type . . . . . 2035 Semi-Metallic  
 Brake Type . . . . . "S" Cam  
 GAWR . . . . . 23,000 lbs.

## GG BRAKE BLOCK RSD SYSTEMS COMPLIANT

Friction Code . . . . . FF  
 Material Type . . . . . 2020 Organic  
 Brake Type . . . . . "S" Cam  
 GAWR . . . . . 23,000 lbs.

## GD BRAKE BLOCK

Friction Code . . . . . FF  
 Material Type . . . . . 2016 Organic  
 Brake Type . . . . . "S" Cam  
 GAWR . . . . . 23,000 lbs.

## GR BRAKE BLOCK RSD SYSTEMS COMPLIANT

Friction Code . . . . . FF  
 Material Type . . . . . 2015 Organic  
 Brake Type . . . . . "S" Cam  
 GAWR . . . . . 20,000 lbs.

## GF BRAKE BLOCK

Friction Code . . . . . FF  
 Material Type . . . . . 2008 Organic  
 Brake Type . . . . . "S" Cam  
 GAWR . . . . . 20,000 lbs.

## GN BRAKE BLOCK

Friction Code . . . . . FF  
 Material Type . . . . . 2017 Organic  
 Brake Type . . . . . "S" Cam  
 GAWR . . . . . 20,000 lbs.

**Economy Grade Friction**

## HV76 BRAKE BLOCK

Friction Code . . . . . FF  
 Material Type . . . . . HV76 Organic  
 Brake Type . . . . . "S" Cam Front Brake  
 GAWR . . . . . 20,000 lbs.

## HV77 BRAKE BLOCK

Friction Code . . . . . FF  
 Material Type . . . . . HV77 Organic  
 Brake Type . . . . . "S" Cam  
 GAWR . . . . . 20,000 lbs.

## HV88 BRAKE BLOCK

Friction Code . . . . . FF  
 Material Type . . . . . HV88 Organic  
 Brake Type . . . . . "S" Cam  
 GAWR . . . . . 23,000 lbs.

**Haldex offers a complete line of Friction Products.  
 Please consult the Haldex Master Catalog ([haldex.com](http://haldex.com)) for our complete listing.**



# Grey-Rock Friction Products (cont'd)

## PART NUMBER FORMAT

**GG 4515 Q R**

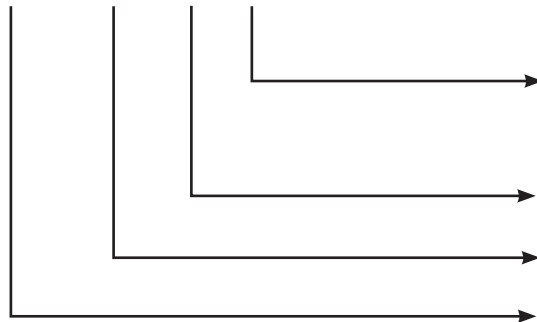

- R** = Reman Shoe
- G** = Reman Gripper Kit - Boxed (2 Shoes and Hardware Kit)
- N** = New Lined Shoe
- J** = New Gripper Kit - Boxed (2 Shoes and Hardware Kit)

### Shoe Core Identifier

**FMSI NUMBER** (Friction Materials Standard Institute, Inc.)

**Product Mix Designate** (Brake Block Description)

## BRAKE LINING DESCRIPTIONS

- AD, BD, CD, D, ED, Etc.** ..... = Lining Drill Pattern (Varies With F.M.S.I. #)
- B\*** ..... = Lining In Bulk (Follows Drill Pattern)
- X\*** ..... = Single Oversized Lining (Follows Drill Pattern)
- XX\*** ..... = Double Oversized Lining (Follows Drill Pattern)
- XXX\*** ..... = Triple Oversized Lining (Follows Drill Pattern)

\* Limited Availability

## COMMON FRICTION WORDS

- Anchor** ..... Refers to the anchor end of a piece of friction material.
- Cam** ..... Refers to the cam end of a piece of friction materials.
- Drill Pattern** ..... Dimensional data referring to holes in specific piece of friction material. The data will include the size, number and location of the holes for each FMSI #.
- FMSI** ..... Stands for "Friction Material Standard Institute".
- FMSI #** ..... Number assigned to a specific dimension of block that may include the radius, thickness, width, length and drill hole specifications.

# Eaton - Air/Single Web Brakes +

## 15" x 4" STANDARD STEER AXLE

- Rivet hole spacing across width (Center to Center) 2 3/4"
- Hardware Kit Service Part No. **CQ66917**
- Width: 4"
- FMSI No.: 1308
- Shoe ID: E
- Core Group: 1308E



Relined Shoe	Relined-Gripper Kit With CQ66917	New Lined Shoe	New-Gripper Kit With CQ66917
GC1308ER	GC1308EG	GC1308EN	GC1308EJ
-	-	GF1308EN	GF1308EJ
GG1308ER	GG1308EG	GG1308EN	GG1308EJ
GR1308ER	GR1308EG	GR1308EN	GR1308EJ
HV761308ER	HV761308EG	HV761308EN	-

## 15" x 4" EXTENDED SERVICE STEER AXLE

- Rivet hole spacing across width (Center to Center) 2"
- Hardware Kit Service Part No. **CQ66917**
- Width: 4"
- FMSI No.: 1443
- Shoe ID: E
- Core Group: 1443TD



Relined Shoe	Relined-Gripper Kit With CQ66917	New Lined Shoe	New-Gripper Kit With CQ66917
GC1443ER	GC1443EG	-	-
-	-	GF1443EN	GF1443EJ
GG1443ER	GG1443EG	GG1443EN	GG1443EJ
GR1443ER	GR1443EG	GR1443EN	GR1443EJ
HV761443ER	HV761443EG	HV761443EN	-

## 16 1/2" x 7" LOW MOUNT

- Hardware Kit Service Part No. **CQ67319**
- Width: 7"
- FMSI No.: 4311
- Shoe ID: E
- Core Group: 4311NS



Relined Shoe	Relined-Gripper Kit With CQ67319	New Lined Shoe	New-Gripper Kit With CQ67319
GC4311ER	GC4311EG	GC4311EN	GC4311EJ
GD4311ER	GD4311EG	GD4311EN	GD4311EJ
GF4311ER	GF4311EG	GF4311EN	GF4311EJ
GG4311ER	GG4311EG	GG4311EN	GG4311EJ
GM4311ER	GM4311EG	-	-
GN4311ER	GN4311EG	GN4311EN	GN4311EJ
GP4311ER	-	GP4311EN	-
GR4311ER	GR4311EG	GR4311EN	GR4311EJ

## Eaton - Air/Double Web and Cast Brakes +

### 16 1/2" x 7" EATON "ES"

- Uses extended wear lining, cam and hardware
- Retainer springs attach to tabs on table anchor end
- Single anchor pin
- Width: 7"
- FMSI No.: 4709
- Shoe ID: ES
- Core Group: 4709
- Hardware Kit Service Part No. **CQ65481**
- Steer Axle Hardware Kit Service Part No. **CQ65444**



Relined Shoe	Relined-Gripper Kit With CQ65481	New Lined Shoe	New-Gripper Kit With CQ65481
GC4709ESR	GC4709ESG	GC4709ESN	GC4709ESJ
GD4709ESR	GD4709ESG	GD4709ESN	GD4709ESJ
GF4709ESR	GF4709ESG	GF4709ESN	GF4709ESJ
GG4709ESR	GG4709ESG	GG4709ESN	GG4709ESJ
GN4709ESR	GN4709ESG	GN4709ESN	GN4709ESJ
GP4709ESR	GP4709ESG	-	-
GR4709ESR	GR4709ESG	GR4709ESN	GR4709ESJ
GZ4709ESR	GZ4709ESG	-	-

### 16 1/2" x 7" EATON "ESII"

- Uses extended wear lining, cam and hardware
- Retainer springs attach on web
- Single anchor pin
- Width: 7"
- FMSI No.: 4709
- Shoe ID: ES2
- Core Group: 4709NS
- Hardware Kit Service Part No. **CQ65477**
- Steer Axle Hardware Kit Service Part No. **CQ65445**



Relined Shoe	Relined-Gripper Kit With CQ65477	New Lined Shoe	New-Gripper Kit With CQ65477
GC4709ES2R	GC4709ES2G	GC4709ES2N	GC4709ES2J
GD4709ES2R	GD4709ES2G	GD4709ES2N	GD4709ES2J
GF4709ES2R	GF4709ES2G	GF4709ES2N	GF4709ES2J
GG4709ES2R	GG4709ES2G	GG4709ES2N	GG4709ES2J
GN4709ES2R	GN4709ES2G	GN4709ES2N	GN4709ES2J
GP4709ES2R	GP4709ES2G	-	-
GR4709ES2R	GR4709ES2G	GR4709ES2N	GR4709ES2J
GZ4709ES2R	GZ4709ES2G	GZ4709ES2N	GZ4709ES2J

## Meritor - Air/Single Web Brakes +

### 15" x 4" MERITOR "Q" LATE STYLE

- Late style shoe table located 1" toward anchor end
- Hardware Kit Service Part No. **CQ69001**
- Minor Hardware Kit Service Part No. **CQ69001**
- Width: 4"
- FMSI No.: 1308
- Shoe ID: Q2
- Core Group: 1308TQN



Relined Shoe	Relined-Gripper Kit With CQ69001	New Lined Shoe	New-Gripper Kit With CQ69001
GC1308Q2R	GC1308Q2G	GC1308Q2N	GC1308Q2J
-	-	GF1308Q2N	GF1308Q2J
GG1308Q2R	GG1308Q2G	GG1308Q2N	GG1308Q2J
GR1308Q2R	GR1308Q2G	GR1308Q2N	GR1308Q2J
HV761308Q2R	HV761308Q2G	HV761308Q2N	-

### 15" x 4" MERITOR "Q" PLUS

- Double Web
- Hardware Kit Service Part No. **CQ65642**
- Width: 4"
- FMSI No.: 4702
- Shoe ID: Q
- Core Group: 4702



Relined Shoe	Relined-Gripper Kit With CQ65642	New Lined Shoe	New-Gripper Kit With CQ65642
GC4702QR	GC4702QG	GC4702QN	-
-	-	GF4702QN	GF4702QJ
GG4702QR	GG4702QG	GG4702QN	GG4702QJ
GR4702QR	GR4702QG	GR4702QN	GR4702QJ

## Meritor - Air/Single Web Brakes (cont'd) +

### 16 1/2" x 7" MERITOR "Q"

- Shoe has hump in web and inside rivet spacing across width of 2.75"
- Hardware Kit Service Part No. **CQ66867**
- Width: 7"
- FMSI No.: 4515
- Shoe ID: Q
- Core Group: 4515TQN



Relined Shoe	Relined-Gripper Kit With CQ66867	New Lined Shoe	New-Gripper Kit With CQ66867
GC4515QR	GC4515QG	GC4515QN	GC4515QJ
GD4515QR	GD4515QG	GD4515QN	GD4515QJ
GF4515QR	GF4515QG	GF4515QN	GF4515QJ
GG4515QR	GG4515QG	GG4515QN	GG4515QJ
GM4515QR	GM4515QG	GM4515QN	GM4515QJ
GN4515QR	GN4515QG	GN4515QN	GN4515QJ
GP4515QR	GP4515QG	GP4515QN	GP4515QJ
GR4515QR	GR4515QG	GR4515QN	GR4515QJ
GZ4515QR	GZ4515QG	GZ4515QN	GZ4515QJ

## Meritor - Air/Double Web and Cast Brakes +

### 16 1/2" x 7" MERITOR "Q" PLUS

#### Current Design

- Shoe has no hump in web and inside rivet spacing across width of 2.75"
- Hardware Kit Service Part No. **CQ66867**
- Width: 7"
- FMSI No.: 4707
- Shoe ID: Q
- Core Group: 4707



Relined Shoe	Relined-Gripper Kit With CQ66867	New Lined Shoe	New-Gripper Kit With CQ66867
GC4707QR	GC4707QG	GC4707QN	GC4707QJ
GD4707QR	GD4707QG	GD4707QN	GD4707QJ
GF4707QR	GF4707QG	GF4707QN	GF4707QJ
GG4707QR	GG4707QG	GG4707QN	GG4707QJ
GM4707QR	GM4707QG	-	-
GN4707QR	GN4707QG	GN4707QN	GN4707QJ
GP4707QR	GP4707QG	GP4707QN	GP4707QJ
GR4707QR	GR4707QG	GR4707QN	GR4707QJ
GZ4707QR	GZ4707QG	GZ4707QN	GZ4707QJ

Haldex offers a complete line of Brake Shoes. Please consult the Haldex Master Catalog ([haldex.com](http://haldex.com)) for a detailed listing of the friction products offered.

# Brake Hardware Kits +

## 12 1/4" TRAILER KITS



CQ67395

Service Part No.	Description
CQ65620	Dexter PQ Style May 1996 and Newer
CQ67395	Meritor "Q" Series Brakes
CQ67397	Standard Forge - Cast Shoes and Weld on Spider
CQ67398	Fabricated Shoes and Weld on Spider
CQ67405	Dana "FT" New Style Fabricated, 1 1/2" Diameter Roller and Weld on Spider
CQ67437	Dana Spicer FC 1996 and Newer 1 1/2" Roller and 1 1/4" Anchor Pin
CQ67503	Converts Standard Forge Cast to Fabricated Shoes
CQ69002	Dana Spicer New Style U-Brake 1 1/4" Diameter Roller
CQ69006	Dana Spicer New Style U-Brake 1 1/2" Diameter Roller

## 16 1/2" KITS



CQ66867

Service Part No.	Description
CQ65444*	Eaton "ES" Combination Kit
CQ65445*	Eaton "ESII" Combination Kit
CQ65477	Eaton "ESII" Second Generation
CQ65479	Eaton "ES" for Meritor
CQ65481	Eaton "ES" First Generation
CQ65520	Bendix® Ford Cargo Series
CQ66867	Meritor "Q" and "Q-Plus" Heavy Duty
CQ66887	Meritor "Q" and "Q-Plus" Relocated Return Spring Shoes and "Q-Plus" Camshafts, Front Axle Brake
CQ66914	Fruehauf "XEM" and "FQ" Heavy Duty
CQ67319	Eaton Single Anchor Pin Heavy Duty
CQ67390	Meritor "P" Series Captive Anchor Pin
CQ69005	Meritor "Q-FL" Series Front Axle

\* Combination Kit contains return springs for "horse collar" bracket application.

## 15" STEER AXLE KITS



CQ69001

Service Part No.	Description
CQ65519	Bendix® Ford Cargo Series Front Axle Brake
CQ65642	Meritor "Q-Plus" Series Brake
CQ66917	Eaton ES Series Single Anchor Pin Front Axle Brakes
CQ66919	Meritor T-Series Front Axle Brakes
CQ66947	Eaton ES Reduced Env Series 15" x 6" Front Axle Brake
CQ66948	Eaton ES Reduced Env Series 15" x 8 5/8" Drive Axle
CQ69001	Meritor "Q" Series Front Axle Brakes Single Web
CQ69007	Spicer Front Axle Brake Double Web
CQ69008	15" x 16 1/2" Dana/Spicer Heavy Axle

Consult the Haldex Master Catalog ([haldex.com](http://haldex.com)) for a complete listing of Friction Products Offered.

# TransitmaX Friction Products

## TRANSITMAX™

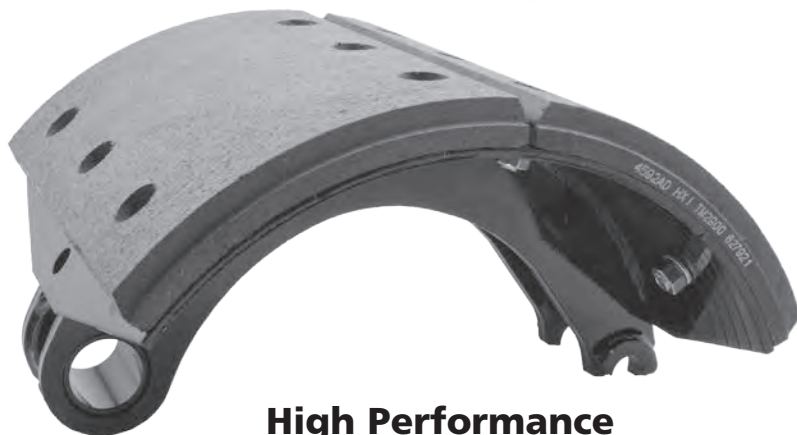

**High Performance  
APTA Certified  
26,000 lb. Brake Lining  
For Transit and  
Coach Applications  
Available in both New and  
Remanufactured Shoes**

### Performance Profile

- Developed for excellent braking performance and extended service life in all transit and coach applications
- Organic fiber based formulation provides outstanding thermal stability and enhanced drum life
- Quiet operation ensures passengers of a safe trouble-free ride
- Minimal growth and swell makes TransitmaX an excellent choice to be combined with automatic brake adjusters and ABS systems
- Standard and Oversize Linings available

Brake: 16 1/2 x 8 5/8  
Axle Load: 26,000 lbs.  
Rolling Radius: 18.3  
AL Factor: 195

Brake: 14 1/2 x 10  
Axle Load: 26,000 lbs.  
Rolling Radius: 20.3  
AL Factor: 210

Friction Average:  
Normal 0.43  
Hot 0.41  
Coefficient - FF

### Quality & Certifications

- FMVSS-121 certified at 26K axle rating
- APTA / AMECA certified
- Manufactured in ISO/TS16949 certified facilities
- Decades of experience Supplying friction for heavy and severe duty vehicles

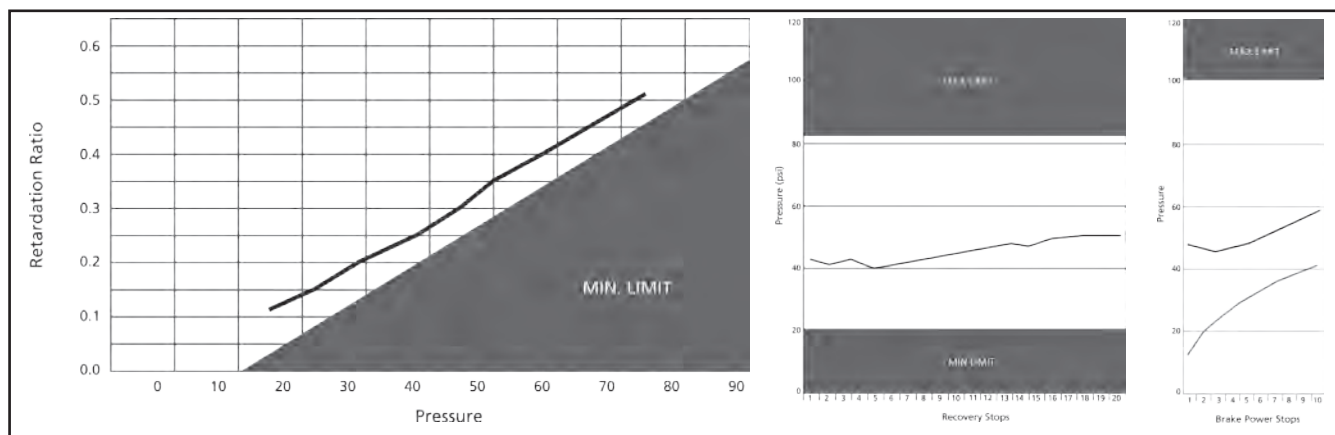

# TransitmaX Friction Products (cont'd)

## Lined Shoes

- Over 30 years experience remanufacturing brake shoes
- Extensive Coast-to-Coast FMSI Inventory
- Available in both New and Remanufactured shoes
- Supplied in boxed or loose shoe configurations, brass or steel bolts, bushing replacement provided
- Nationwide Vehicle Down Response
- Standardized production processes ensure consistent quality



## Over 30 Quality Checkpoints and Inspections Per Shoe:

- Table Wear & Damage
- Elongated Rivet Holes
- Web Damage
- Coating Coverage
- Anchor & Roller End Wear/Damage
- Lining Fit/Rivet Torque
- Shoe Stretch & Collapse

**ALL  
REMANUFACTURED SHOES  
ARE  
RELINED  
ACCORDING  
TO APTA  
RECOMMENDED PRACTICES**

## North America Friction Center Locations





# TransitmaX Friction Products (cont'd)

TRANSIT BLOCK	
	TM
Friction Code	FF
Material Type	Organic
Brake Type	"S" Cam
GAWR	26,000 lbs.
Certification	APTA / AMECA Approved

## PART NUMBER FORMAT - Transit

**TM 4592 686 L B G XX**

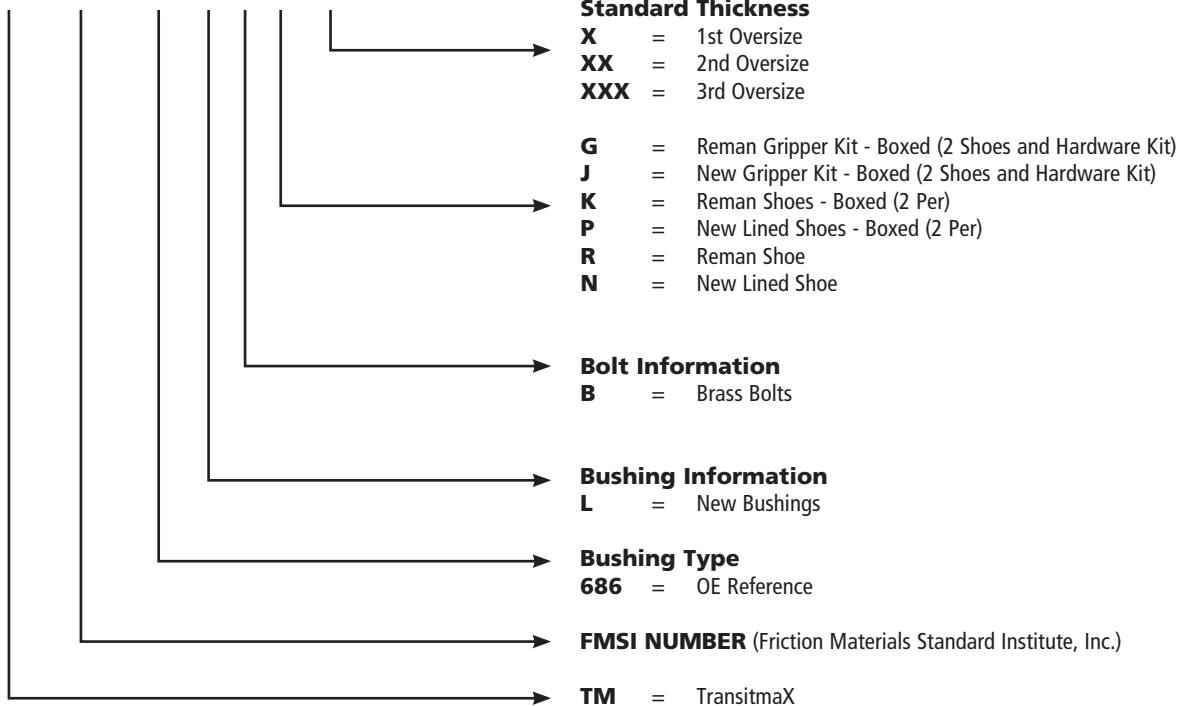

## Fasteners

Fastener Part No.	Description
BA3816100B	3/8" x 1" Brass Bolt Assembly
BA3816125B	3/8" x 1 1/4" Brass Bolt Assembly

# MERITOR "W" Series Cam Brake +

MERITOR  
"W" SERIES CAM BRAKE  
4228-1157  
Front Axle Brake

## 14 1/2" x 6"

OE Number A4-32222-M-1157

Core Group 4228 1 Pc Bushing

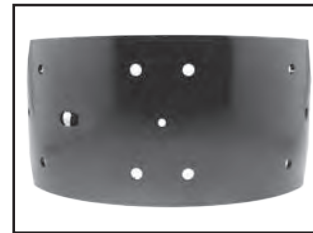

Lining Part No.	Description
TM4228FD	Standard Thickness
TM4228FDX	First Oversize
TM4228FDXX	Double Oversize
TM4228FDXXX	Triple Oversize

### POPULAR LINED SHOE NUMBERS

Haldex Part No.	New Bushing	Fastener Lined Shoe	Shoe Type	Configuration	Hardware Included	Lining Thickness
TM42281157BJ	Yes	Brass Bolt	New	Boxed (2 Per)	Yes	Standard
TM42281157BP	Yes	Brass Bolt	New	Boxed (2 Per)	No	Standard
TM42281157LBG	Yes	Brass Bolt	Reman	Boxed (2 Per)	Yes	Standard
TM42281157LBK	Yes	Brass Bolt	Reman	Boxed (2 Per)	No	Standard
TM42281157BN	Yes	Brass Bolt	New	Single Shoe	No	Standard
TM42281157LBR	Yes	Brass Bolt	Reman	Single Shoe	No	Standard

### BRAKE HARDWARE KIT

PART No. CQ69011



# MERITOR "W" Series Cam Brake +

MERITOR  
"W" SERIES CAM BRAKE  
4592-686  
Rear Axle Brake

## 14 1/2" x 10"

OE Number            A1-3722-J-686

Core Group

4592SB

2 Pc Bushing



Lining Part No.	Description
TM4592AD	Standard Thickness
TM4592ADX	First Oversize
TM4592ADXX	Double Oversize
TM4592ADXXX	Triple Oversize

### POPULAR LINED SHOE NUMBERS

Haldex Part No.	New Bushing	Fastener Lined Shoe	Shoe Type	Configuration	Hardware Included	Lining Thickness
TM4592686BJ	Yes	Brass Bolt	New	Boxed (2 Per)	Yes	Standard
TM4592686BP	Yes	Brass Bolt	New	Boxed (2 Per)	No	Standard
TM4592686LBG	Yes	Brass Bolt	Reman	Boxed (2 Per)	Yes	Standard
TM4592686LBK	Yes	Brass Bolt	Reman	Boxed (2 Per)	No	Standard
TM4592686BN	Yes	Brass Bolt	New	Single Shoe	No	Standard
TM4592686LBR	Yes	Brass Bolt	Reman	Single Shoe	No	Standard

### BRAKE HARDWARE KIT

PART No. CQ69013

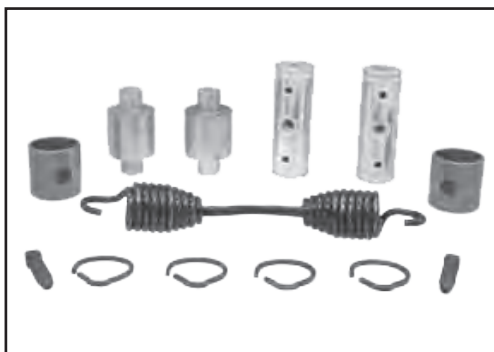

# MERITOR "W" Series Cam Brake +

MERITOR  
 "W" SERIES CAM BRAKE  
 4592-824  
 Rear Axle Brake

## 14 1/2" x 10"

OE Number A1-3722-R-824

Core Group 4592BB 1 Pc Bushing

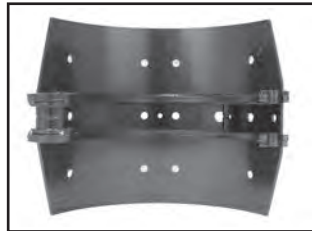

Lining Part No.	Description
TM4592AD	Standard Thickness
TM4592ADX	First Oversize
TM4592ADXX	Double Oversize
TM4592ADXXX	Triple Oversize

### POPULAR LINED SHOE NUMBERS

Haldex Part No.	New Bushing	Fastener Lined Shoe	Shoe Type	Configuration	Hardware Included	Lining Thickness
TM4592824BJ	Yes	Brass Bolt	New	Boxed (2 Per)	Yes	Standard
TM4592824BP	Yes	Brass Bolt	New	Boxed (2 Per)	No	Standard
TM4592824LBG	Yes	Brass Bolt	Reman	Boxed (2 Per)	Yes	Standard
TM4592824LBK	Yes	Brass Bolt	Reman	Boxed (2 Per)	No	Standard
TM4592824BN	Yes	Brass Bolt	New	Single Shoe	No	Standard
TM4592824LBR	Yes	Brass Bolt	Reman	Single Shoe	No	Standard

### BRAKE HARDWARE KIT

PART No. CQ69014

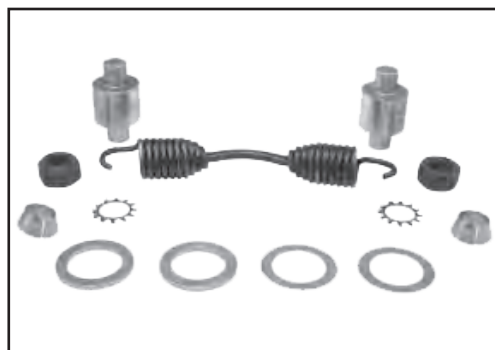

# MAN Cast Brake +

MAN  
CAST BRAKE  
4656 Cast  
Front Axle Brake

## 16.14" x 6.3"

OE Number 81502016187

Core Group 4656 1 Pc Bushing



Lining Part No.	Description
TM4656D	Standard Thickness
TM4656DX	First Oversize
TM4656DXX	Double Oversize
TM4656DXXX	Triple Oversize

### POPULAR LINED SHOE NUMBERS

Haldex Part No.	New Bushing	Fastener Lined Shoe	Shoe Type	Configuration	Hardware Included	Lining Thickness
TM4656TCJ	Yes	Rivet	New	Boxed (2 Per)	Yes	Standard
TM4656TCLG	Yes	Rivet	Reman	Boxed (2 Per)	Yes	Standard
TM4656TCLK	Yes	Rivet	Reman	Boxed (2 Per)	No	Standard
TM4656TCP	Yes	Rivet	New	Boxed (2 Per)	No	Standard
TM4656TCN	Yes	Rivet	New	Single Shoe	No	Standard
TM4656TCLR	Yes	Rivet	Reman	Single Shoe	No	Standard

### BRAKE HARDWARE KIT

PART No. CQ69019



# MAN Cast Brake +

MAN  
CAST BRAKE  
4657 Cast  
Rear Axle Brake

## 16.14" x 8.66"

OE Number 81502016188

Core Group 4657 1 Pc Bushing



Lining Part No.	Description
TM4657D	Standard Thickness
TM4657DX	First Oversize
TM4657DXX	Double Oversize
TM4657DXXX	Triple Oversize

### POPULAR LINED SHOE NUMBERS

Haldex Part No.	New Bushing	Fastener Lined Shoe	Shoe Type	Configuration	Hardware Included	Lining Thickness
TM4657TCJ	Yes	Rivet	New	Boxed (2 Per)	Yes	Standard
TM4657TCLG	Yes	Rivet	Reman	Boxed (2 Per)	Yes	Standard
TM4657TCLK	Yes	Rivet	Reman	Boxed (2 Per)	No	Standard
TM4657TCP	Yes	Rivet	New	Boxed (2 Per)	No	Standard
TM4657TCN	Yes	Rivet	New	Single Shoe	No	Standard
TM4657TCLR	Yes	Rivet	Reman	Single Shoe	No	Standard

### BRAKE HARDWARE KIT

PART No. CQ69019



# MERITOR Cast Plus Brake +

**MERITOR  
CAST PLUS BRAKE  
4715 Cast  
Front Axle Brake**

## 16 1/2" x 6"

**OE Number** A-3222-H-2296

**Core Group**

4715CAST

2 Pc Bushing



Lining Part No.	Description
TM4715AD	Standard Thickness
TM4715ADX	First Oversize
TM4715ADXX	Double Oversize
TM4715ADXXX	Triple Oversize

### POPULAR LINED SHOE NUMBERS

Haldex Part No.	New Bushing	Fastener Lined Shoe	Shoe Type	Configuration	Hardware Included	Lining Thickness
TM4715TCJ	Yes	Rivet	New	Boxed (2 Per)	Yes	Standard
TM4715TCLG	Yes	Rivet	Reman	Boxed (2 Per)	Yes	Standard
TM4715TCLK	Yes	Rivet	Reman	Boxed (2 Per)	No	Standard
TM4715TCP	Yes	Rivet	New	Boxed (2 Per)	No	Standard
TM4715TCN	Yes	Rivet	New	Single Shoe	No	Standard
TM4715TCLR	Yes	Rivet	Reman	Single Shoe	No	Standard

### BRAKE HARDWARE KIT

**PART No. CQ67409**



# MERITOR Cast Plus Brake +

MAN  
CAST BRAKE  
4728 Cast  
Rear Axle Brake

## 16 1/2" x 8 5/8"

OE Number A-3222-F-2294

Core Group 4728CAST 2 Pc Bushing

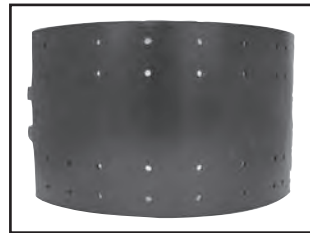
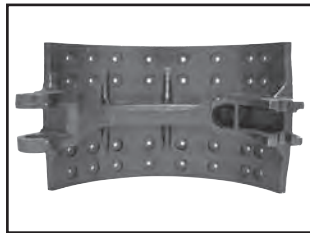

Lining Part No.	Description
TM4728AD	Standard Thickness
TM4728ADX	First Oversize
TM4728ADXX	Double Oversize
TM4728ADXXX	Triple Oversize

### POPULAR LINED SHOE NUMBERS

Haldex Part No.	New Bushing	Fastener Lined Shoe	Shoe Type	Configuration	Hardware Included	Lining Thickness
TM4728TCJ	Yes	Rivet	New	Boxed (2 Per)	Yes	Standard
TM4728TCLG	Yes	Rivet	Reman	Boxed (2 Per)	Yes	Standard
TM4728TCLK	Yes	Rivet	Reman	Boxed (2 Per)	No	Standard
TM4728TCP	Yes	Rivet	New	Boxed (2 Per)	No	Standard
TM4728TCN	Yes	Rivet	New	Single Shoe	No	Standard
TM4728TCLR	Yes	Rivet	Reman	Single Shoe	No	Standard

### BRAKE HARDWARE KIT

PART No. CQ67409







# It's a new day for truck parts.

Get your fleet running like new with a brand of remanufactured parts that are better than new. Like-Nu™ parts aren't just rebuilt or restored, they're remanufactured to Like-Nu standards.

Each component stands on its own merit, with no compromise. Strong warranties back the parts we make, so our products are as reliable as new parts for a fraction of the price. In fact, the only thing you're giving up is the extra cost.

Ask your Haldex sales professional about Like-Nu.

## Like-Nu™

Like-Nu – a Haldex brand.

# Double duty.

The GeminiMDx® air dryer system was built for transit and vocational braking. GeminiMDx doubles air treatment capacity while purifying brake system air to protect parts from corrosion and damage.

The rugged manifold design of the GeminiMDx delivers low initial and lifecycle costs and eliminates weight, trouble and complexity. Built-in components improve reliability and economy. And flexible Haldex design cuts service hours.

Ask your Haldex sales professional about GeminiMDx.

[haldex.com](http://haldex.com)

*High capacity, low cost, reliable performance and the cleanest air of any dual treatment system* GEMINI<sup>MDx</sup>

# Fuhgeddaboutit.

The new Reservoir Purge Valve from Haldex.



Drivers have a lot to remember. So, draining the trailer reservoir valve is sometimes forgotten.

Haldex RPV remembers for you, automatically purging any fluid in the tank when your parking brake is set or emergency air is released.

The RPV helps keep water, oils and contaminants out of the pneumatic system, and it's easy to install, retrofit and maintain.

The Reservoir Purge Valve from Haldex.  
Get it. Don't forget it.

For questions or documentation, contact your Haldex sales professional.



[haldex.com](http://haldex.com)

Lightweight brake.  
**Heavyweight  
stopping power.**



**ModuLT**

Superior design.  
Quick, easy maintenance.  
More uptime.







With more than 100 years of intensely focused innovation, Haldex holds unrivaled expertise in brake systems and air suspension systems for heavy trucks, trailers and buses. We live and breathe our business, delivering robust, technically superior solutions born from deep insight into our customers' reality.

By concentrating on our core competencies and following our strengths and passions, we combine both the operating speed and flexibility required by the market. Collaborative innovation is not only the essence of our products - it is also our philosophy. Our employees, spread on four continents, are constantly challenging the conventional and strive to ensure that the products we deliver create unique value for our customers and all end-users.

**To learn more, contact your Haldex sales professional.**

United States 816-891-2470  
Canada 519-621-6722  
Mexico 52-81-81569500

For additional contact information  
or to learn more about Haldex,  
please visit [Haldex.com](http://Haldex.com)

**L20024**  
US Rev. 7/19 5M LS  
Printed In The USA