

**Nummerpladelygte**  
**Numberplate lamp**

(E)

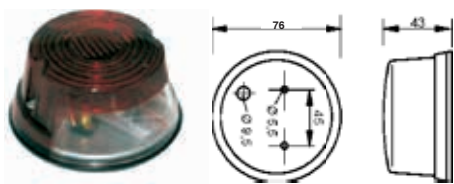

**DK** Baglygte med nummerpladelys. Bundplade udført i sort kunststof. Fladstiktilslutning med kabelgennemføring gennem gummitylle.

**GB** Tail lamp with numberplate lamp. Black plastic base. Flat-plug connections with cable lead through rubber grommet.

	Artikel nr.
Baglygte med nummerpladelys / Tail lamp with numberplate lamp SAW ref.: 21.028-071	<b>098 200 915</b>

Reserve dele / Spare parts	
Lygteglas / Lens	<b>098 290 917</b>

**Nummerpladelygte**  
**Numberplate lamp**

(E)

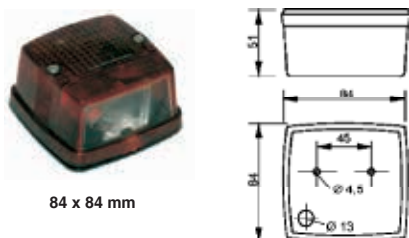

84 x 84 mm

**DK** Bag- & stoplygte med nummerpladelys. Bundplade udført i sort kunststof. Fladstiktilslutning med kabelgennemføring gennem gummitylle.

**GB** Tail- & stoplamp with numberplate lamp. Black plastic base. Flat-plug connections with cable lead through rubber grommet.

	Artikel nr.
Bag- stoplygte med nummerpladelys / Tail-stop lamp with numberplate lamp SAW ref.: 21.028-071	<b>098 210 990</b>

Reserve dele / Spare parts	
Lygteglas / Lens	<b>098 290 992</b>

**Nummerpladelygte**  
**Numberplate lamp**

(E) e

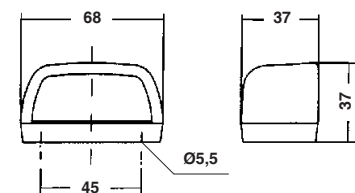

**DK** Lygtehus i sort kunststof med integreret lygteglas. Fladstiktilslutning med kabelgennemføring gennem gummitylle.

**GB** Black plastic housing with integrated lens. Flat-plug connections with cable lead through rubber grommet.

	Artikel nr.
Nummerpladelygte / Numberplate lamp Sacex ref.: 27.51.090; 27.51.000	<b>098 254 170</b>

**Nummerpladelygte**  
**Numberplate lamp**

(E)

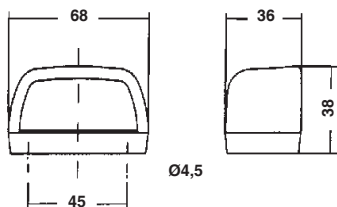

**DK** Lygtehus i sort kunststof med integreret lytglas. Fladstiktilslutning med kabelgennemføring gennem gummitylle.

**GB** Black plastic housing with integrated lens. Flat-plug connections with cable lead through rubber grommet.

	Artikel nr.
Nummerpladelygte / Numberplate lamp Britax ref.: 868.00	098 254 171

**Nummerpladelygte**  
**Numberplate lamp**

(E)

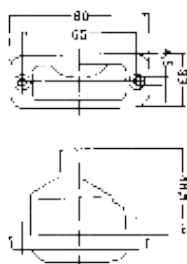

**DK** Beregnet for indbygning. Med gummihus. Fladstiktilslutning. Indbygningsmål: 56 x 22 mm.

**GB** Build-in version. With rubber housing. Flat-plug connection. Build in measurement: 56 x 22 mm.

	Artikel nr.
Nummerpladelygte / Numberplate lamp	098 254 180

**Nummerpladelygte**  
**Numberplate lamp**

(E)

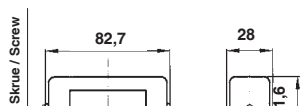

**DK** Lygtehus i sort kunststof med integreret lytglas. Fladstiktilslutning med kabelgennemføring gennem gummitylle.

**GB** Black plastic housing with integrated lens. Flat-plug connections with cable lead through rubber grommet.

	Artikel nr.
Nummerpladelygte / Numberplate lamp SAW ref.: 25.011-021	098 254 111

**Nummerpladelygte**  
**Numberplate lamp**

(E)

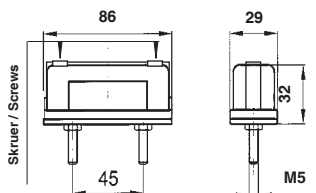

**DK** Lygtehus i sort kunststof med integreret lytteglas. Fladstiktilslutning med kabelgennemføring gennem gummitylle.

**GB** Black plastic housing with integrated lens. Flat-plug connections with cable lead through rubber grommet.

	<b>Artikel nr.</b>
Nummerpladelygte / Numberplate lamp SAW ref.: 25.011-021	<b>098 254 112</b>

**Nummerpladelygte**  
**Numberplate lamp**

(E) E2 7001

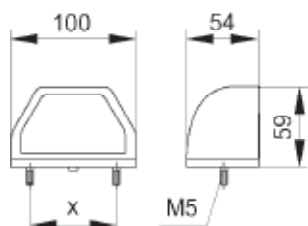

**DK** Lygtehus i sort kunststof med integreret lytteglas og forstærket pakning. 2 monteringsbolte, boltafstand x = 45, 72, 75 mm. Fladstiktilslutning med kabelgennemføring gennem PG7 forskrunding.

**GB** Black plastic housing with integrated lens and reinforced gasket. 2 mounting bolts, distance of x = 45, 72, 75 mm. Flat-plug connections and cable lead through PG7 cable seal.

	<b>Artikel nr.</b>
Nummerpladelygte / Numberplate lamp Valeo ref.: 196 020; EPP 96	<b>098 254 096</b>

**Nummerpladelygte**  
**Numberplate lamp**

(E)

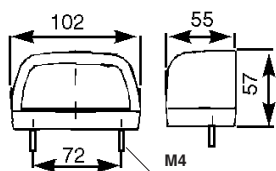

**DK** Lygtehus i sort kunststof med integreret lytteglas. Fladstiktilslutning med kabelgennemføring gennem gummitylle.

**GB** Black plastic housing with integrated lens. Flat-plug connections with cable lead through rubber grommet.

	<b>Artikel nr.</b>
Nummerpladelygte / Numberplate lamp SAW ref.: 25.087-001	<b>998 254 160</b>

**Nummerpladelygte**  
**Numberplate lamp**

(E)

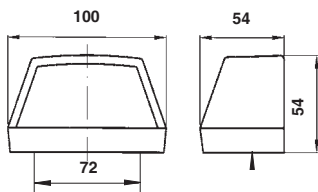

**DK** Lygtehus i sort kunststof med integreret lytteglas. Fladstiktilslutning med kabelgennemføring gennem gummitylle.

**GB** Black plastic housing with integrated lens. Flat-plug connections with cable lead through rubber grommet.

	<b>Artikel nr.</b>
Nummerpladelygte / Numberplate lamp SAW ref.: 25.087-001	<b>098 254 161</b>

**Nummerpladelygte**  
**Numberplate lamp**

(E)

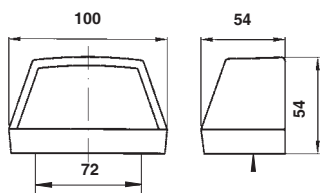

**DK** Baglygte i rødt kunststof med integreret lytteglas for nummerpladelys. Fladstiktilslutning med kabelgennemføring gennem gummitylle.

**GB** Red plastic tail lamp with integrated lens for numberplate illumination. Flat-plug connections with cable lead through rubber grommet.

	<b>Artikel nr.</b>
Baglygte med nummerpladelys / Tail lamp with illumination for numberplate	<b>098 254 166</b>

**Nummerpladelygte**  
**Numberplate lamp**

(E)

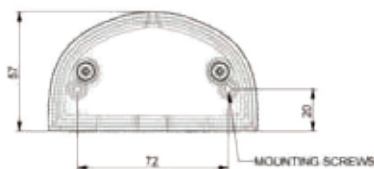
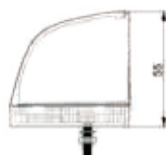

**DK** Lygtehus i sort kunststof med integreret lytteglas. Fladstiktilslutning med kabelgennemføring gennem gummitylle.

**GB** Black plastic housing with integrated lens. Flat-plug connections with cable lead through rubber grommet.

	<b>Artikel nr.</b>
Nummerpladelygte / Numberplate lamp	<b>098 254 151</b>

**Nummerpladelygte**  
**Numberplate lamp**

(E)

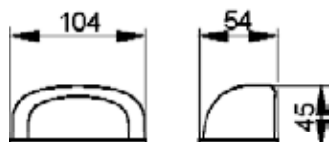

**DK** Lygtehus i sort kunststof med integreret lygteglas for nummerpladelys. Fladstiktilslutning med kabelgennemføring gennem gummitylle.

**GB** Black plastic housing with integrated lens for numberplate illumination. Flat-plug connections with cable lead through rubber grommet.

	<b>Artikel nr.</b>
Nummerpladelygte / Numberplate lamp SAW ref.: 25.012-071, 25.012-031	<b>098 254 136</b>

**Nummerpladelygte**  
**Numberplate lamp**

(E)

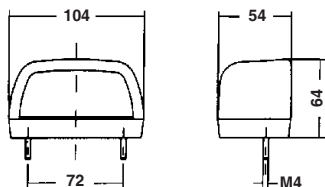

**DK** Lygtehus i sort kunststof med integreret lygteglas for nummerpladelys. Høj sokkel. Fladstiktilslutning med kabelgennemføring gennem gummitylle.

**GB** Black plastic housing with integrated lens for numberplate illumination. Tall base. Flat-plug connections with cable lead through rubber grommet.

	<b>Artikel nr.</b>
Nummerpladelygte / Numberplate lamp SAW ref.: 25.012-011, 25.012-051	<b>098 254 126</b>

**LED-nummerpladelygte**  
**LED numberplate lamp**

(E)

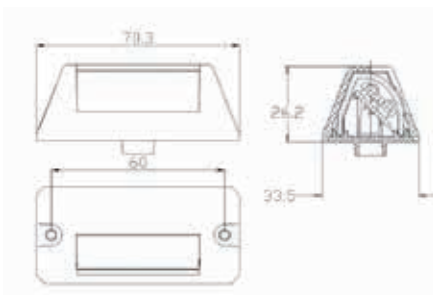

**DK** Sort kunststofhus.

**GB** Black plastic housing

		<b>Artikel nr.</b>
LED-nummerpladelygte / LED numberplate lamp	12V	<b>098 254 210</b>

**LED-nummerpladelygte**  
**LED numberplate lamp**

(E)

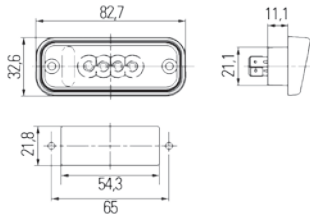

**DK** 4 lysdioder. Sort kunststoffhus. Fladstikstilslutning. Bi-polaritet.

**GB** 4 LED's. Black plastic housing. Flat plug connections. Bi-polarity.

		Artikel nr.
LED-nummerpladelygte / LED numberplate lamp Hella: 2KA 010 278-011	24V/0,4W	<b>098 254 190</b>

**LED-nummerpladelygte**  
**LED numberplate lamp**

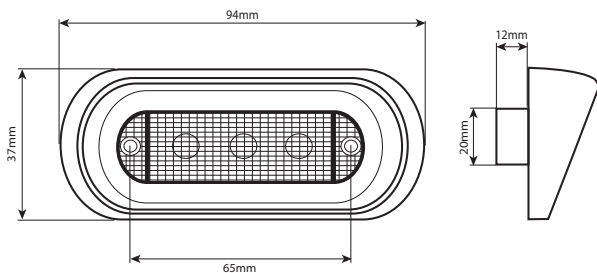

**DK** 3 lysdioder. 30 cm. tilslutningskabel m/2-pol. multistik.

**GB** 3 LED's. 30 cm. connection cable with 2-pol. connector

		Artikel nr.
LED-nummerpladelygte / LED numberplate lamp	24V/0,4W	<b>098 254 195</b>

**LED-nummerpladelygte**  
**LED numberplate lamp**

(E)

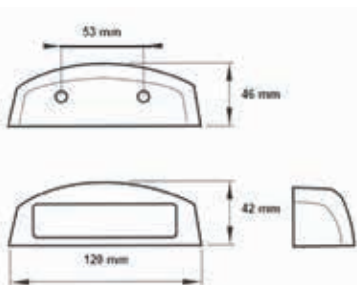

**DK** Sort kunststoffhus.

**GB** Black plastic housing.

		Artikel nr.
LED-nummerpladelygte / LED numberplate lamp	10-30V	<b>098 254 230</b>

**LED-nummerpladelygte**  
**LED numberplate lamp**

(E)

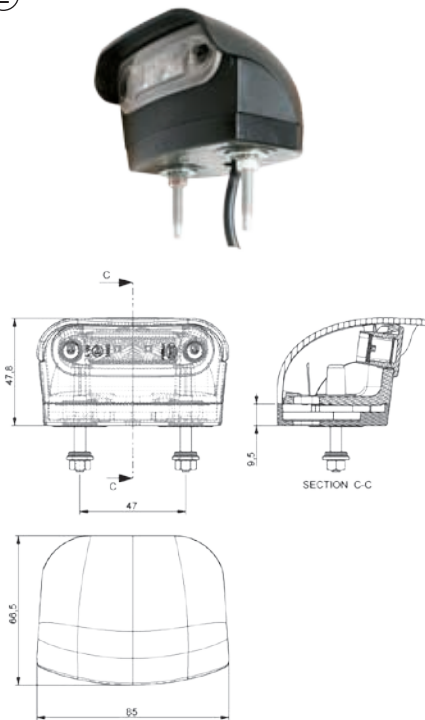

**DK** 2 lysdioder, 12V eller 24V. 1m tilslutningskabel. Hus fremstillet i ABS, lygteglas i PMMA. Arbejdstemperatur: -20°C - + 60°C.

**GB** 2 LED's. 1m connection cable. ABS housing, PMMA lens. Working temperature: -20°C- +60°C.

		Artikel nr.
LED-nummerpladelygte / LED numberplate lamp Hella: 2KA 959 640-607	12V/0,4W	<b>098 254 272</b>
LED-nummerpladelygte / LED numberplate lamp Hella: 2KA 959 640-607	24V/0,4W	<b>098 254 274</b>

**LED-nummerpladelygte**  
**LED numberplate lamp**

(E)

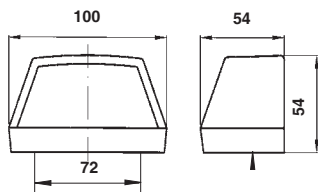

**DK** LED nummerpladelygter. Med udskiftelig diodeenhed, som også passer i 098 254 161/166 (model med glødelampe), hvilket gør det nemt at "opgradere" til LED. Fladstiktilslutning med kabelgennemføring gennem gummitylle, eller vha. 0,5m kabel m/click-in-adapter.

**GB** LED numberplate lamps. With interchangeable LED unit, that also fits into 098 254 161/166 (bulb version), making it very easy to "upgrade" to LED. Flat plug connections with cable lead through rubber grommet, or 0,5m connection cable with click-in adapter.

Med integreret baglys / With integrated tail light		Artikel nr.
LED-nummerpladelygte / LED numberplate lamp	12V	<b>098 254 165</b>
LED-nummerpladelygte / LED numberplate lamp	24V	<b>098 254 167</b>
LED-nummerpladelygte / LED numberplate lamp 0,5 m./click-in adapter	24V	<b>098 254 251</b>

Sort kunststofhus / Black plastic housing		
LED-nummerpladelygte / LED numberplate lamp	12V	<b>098 254 163</b>
LED-nummerpladelygte / LED numberplate lamp	24V	<b>098 254 162</b>
LED-nummerpladelygte / LED numberplate lamp 0,5 m./click-in adapter	24V	<b>098 254 251</b>

Reservedele / Spare parts	
LED-enhed / LED unit 12V	<b>098 254 169</b>
LED-enhed / LED unit 24V	<b>098 254 168</b>

**LED-nummerpladelygte**  
**LED numberplate lamp**

(E)

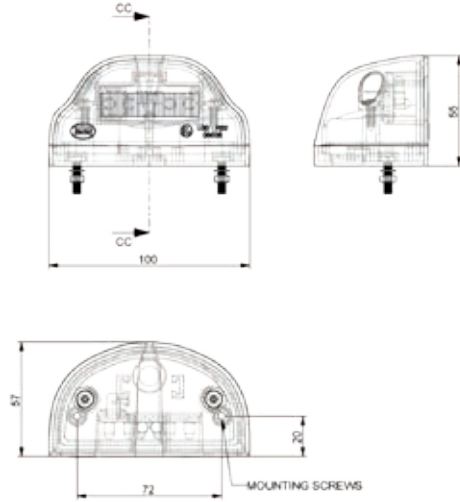

**DK** 6 lysdioder. Tilslutning gennem gummigennemføring eller vha. 0,5m kabel m/ click-in-adapter. Hus fremstillet i ABS. Polbeskyttet. Arbejdstemperatur: -20°C - +60°C.

**GB** 6 LED's. Cable lead through rubber grommet or 0,5m connection cable with click-in adapter. Plastic housing. Bi-polarity. Working temperature: -20°C - +60°C.

Med integreret baglys / With integrated tail light		Artikel nr.
LED-nummerpladelygte / LED numberplate lamp	12V/0,4W	<b>098 254 243</b>
LED-nummerpladelygte / LED numberplate lamp	24V/0,4W	<b>098 254 246</b>
LED-nummerpladelygte / LED numberplate lamp 0,5m./click-in adapter	12V/0,4W	<b>098 254 248</b>
LED-nummerpladelygte / LED numberplate lamp 0,5m./click-in adapter	24V/0,4W	<b>098 254 249</b>

Sort kunststofhus / Black plastic housing		
LED-nummerpladelygte / LED numberplate lamp	12V/0,4W	<b>098 254 242</b>
LED-nummerpladelygte / LED numberplate lamp	24V/0,4W	<b>098 254 244</b>
LED-nummerpladelygte / LED numberplate lamp 0,5m./click-in adapter Ref: 36-3509-007	12V/0,4W	<b>098 254 245</b>
LED-nummerpladelygte / LED numberplate lamp 0,5m./click-in adapter Ref: 36-3604-007	24V/0,4W	<b>098 254 247</b>

**LED-nummerpladelygte**  
**LED numberplate lamp**

(E)



098 254 115

098 254 114

**DK** 20 cm. tilslutningskabel.

**GB** 20 cm. connection cable.

Med integreret baglys / With integrated tail light		Artikel nr.
LED-nummerpladelygte / LED numberplate lamp	12-24V	<b>098 254 115</b>

Sort kunststofhus / Black plastic housing		
LED-nummerpladelygte / LED numberplate lamp	12-24V	<b>098 254 114</b>

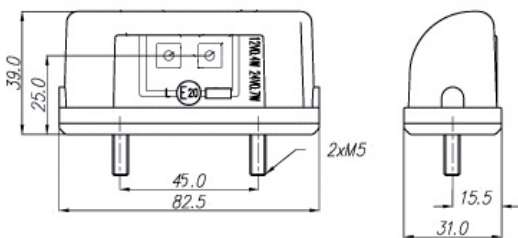



**LED-nummerpladelygte**  
**LED numberplate lamp**

Ⓔ GGVS

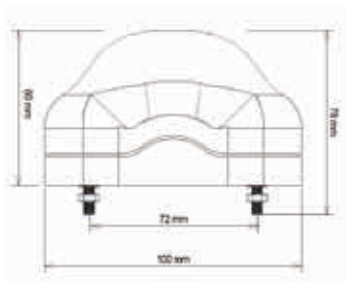

**DK** Lygtehus udført i sort kunststof med 45 cm kabel med "Click in" kabel-tilslutningsstik. Beskyttet mod kraftige vandsprøjt, IP54.

**GB** Lamp housing made in plastic with 45 cm cable with "Click in" cable-connector. Water splash protected, IP54.

		<b>Artikel nr.</b>
LED-nummerpladelygte / LED numberplate lamp	24V	<b>36-3604-007</b>

**Lygtesæt**  
**Rear lamp kit**

Ⓔ e

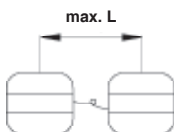

**DK** Med påmonterede magneter. Bag-stop-blinklygte med nummerpladelys. Med 7,5 m tilslutningskabel med 7-polet 12V stik monteret. Lygtesæt leveres inkl. 12V lamper.

**GB** For magnetic mounting  
Tail-stop-flasher lamp with illumination for numberplate. With 7,5 m connection cable with 7-pin 12V plug fitted. Lamp kit supplied with 12V bulbs.

		<b>Artikel nr.</b>
Lygtesæt / Rear lamp kit	L = 2,5 m.	<b>098 259 820</b>